

SICIS®
HOME COLLECTION

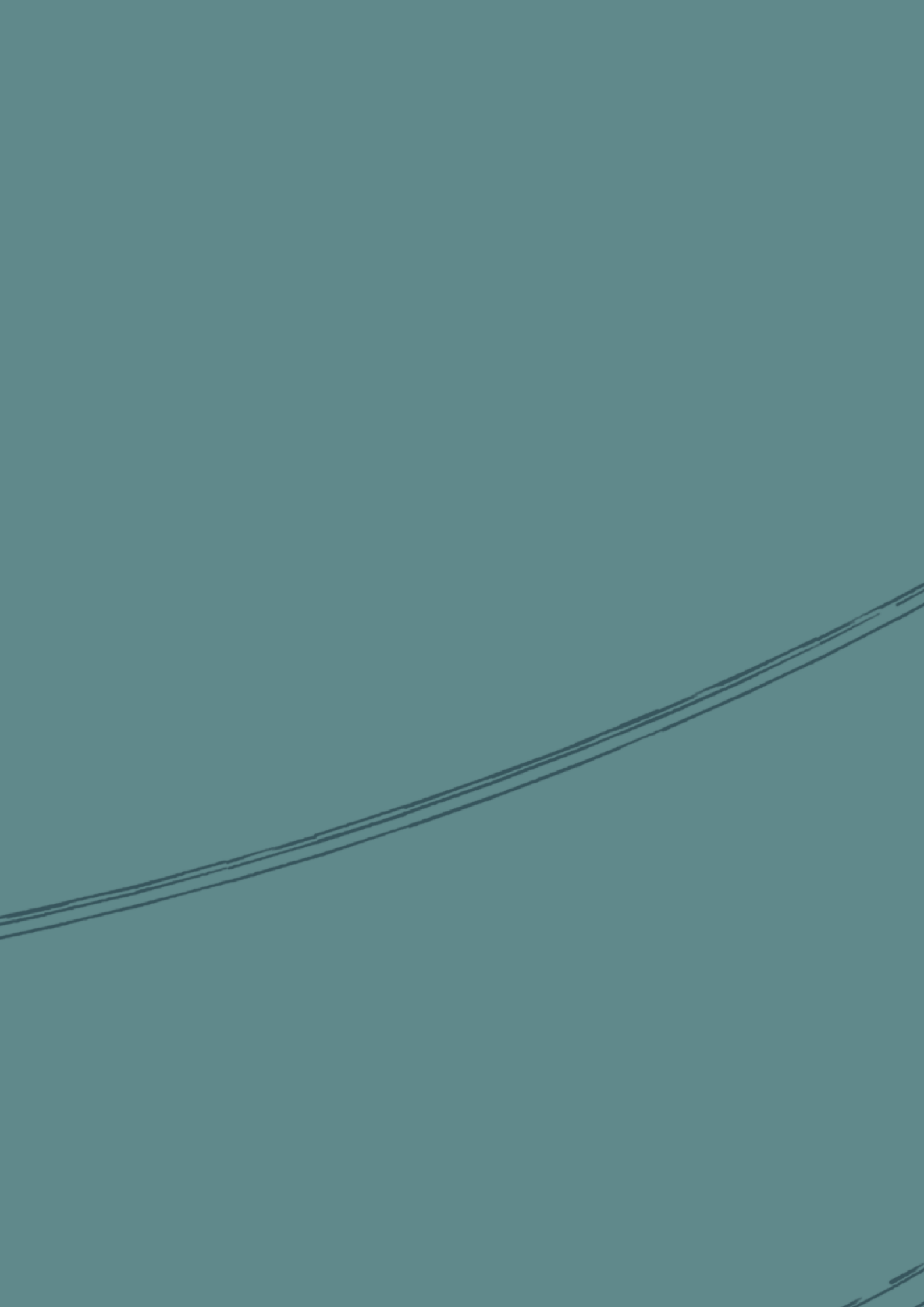

mars
coffee table

MADE IN ITALY



SICIS®
HOME COLLECTION

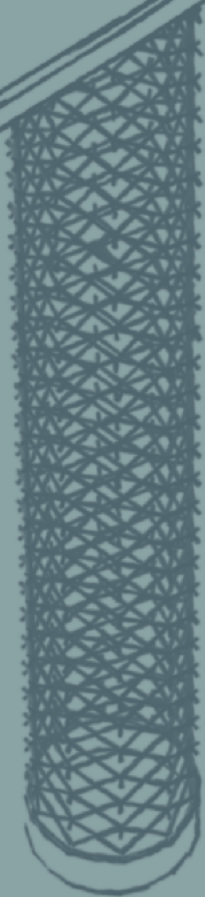

mars

coffee table





mars

coffee table

designed by Massimiliano Raggi



mars

coffee table

La forza e la flessibilità del vetro, rappresentano in questo tavolo il fascino della natura e la sua immensità.

L'armonia delle forme e la scelta dei materiali innovativi, lo rende un pezzo di design capace di adattarsi continuamente all'impostazione delle abitazioni contemporanee e ai nuovi modi che le persone trovano per viverle.

Tutto deve avere un'anima e un motivo per esistere, una semplicità seducente che va al di là delle regole di stile e si fonde con capacità di creare oggetti che vivono insieme a noi. Una bellezza modernista.

Una mescolanza di razionalismo e poesia, calma e riflessione. Un tavolo che ricorda la danza di una ballerina, soave dai movimenti ben impostati.

The power and flexibility of glass represent both the charm and the unlimitedness of Nature in this table. The harmony of shapes and the selection of innovative materials make it a design object capable of continuously adapting to the style of contemporary houses and the new ways people choose to live them.

Everything needs to have a soul and a reason to exist, a seductive simplicity that goes beyond the rigid style rules and merges with the ability to create "living objects".

A modernist beauty. A mixture of rationalism and poetry, calm and reflection. A table that resembles the gentle and well-designed dancer's movements.

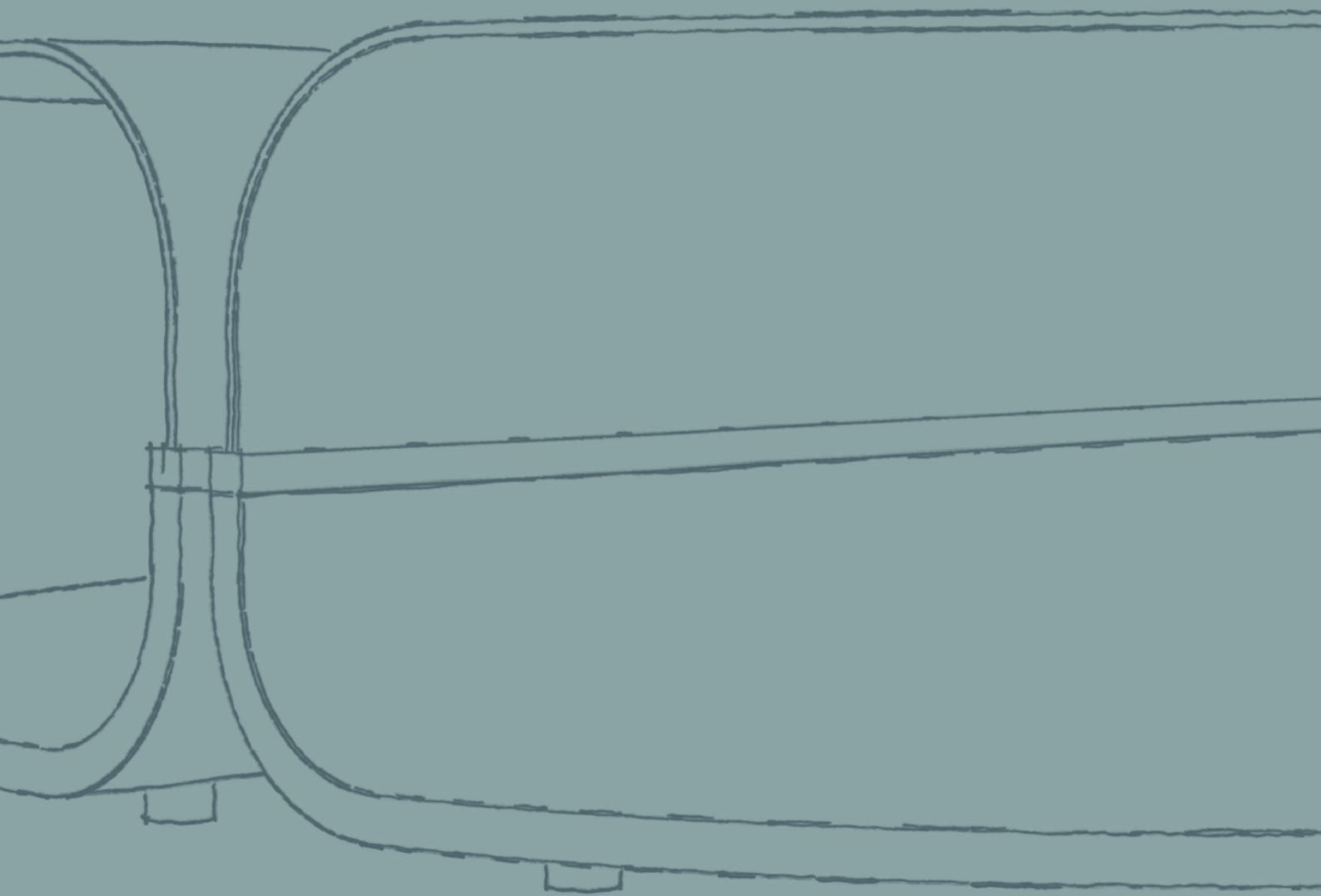

mars_big 140_{cm.}

coffee table

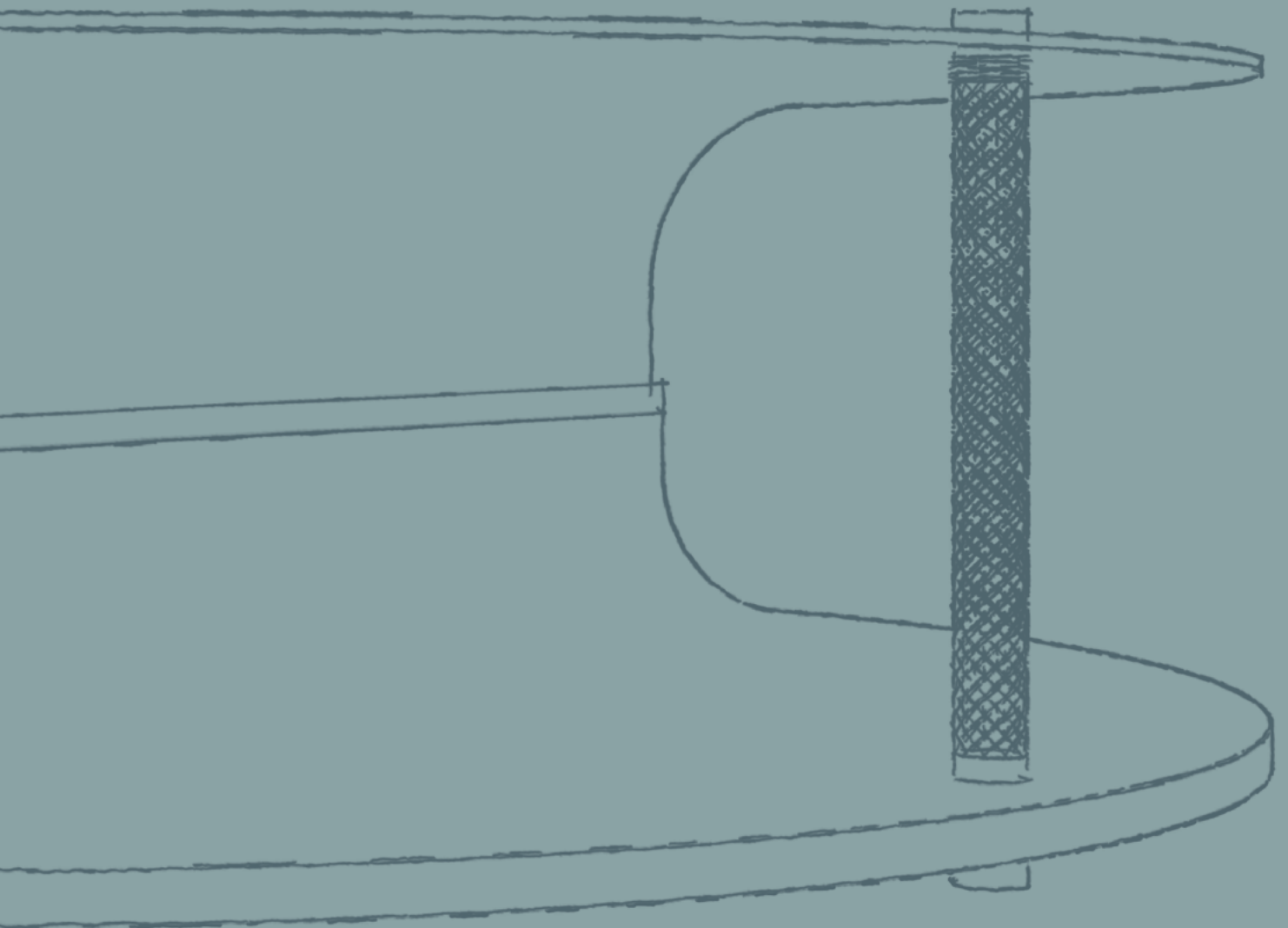



SOLUTION 01

mars_big_140

vetrite - waves _ legno - laccato nero lucido
vetrite - waves _ wood - glossy black polished

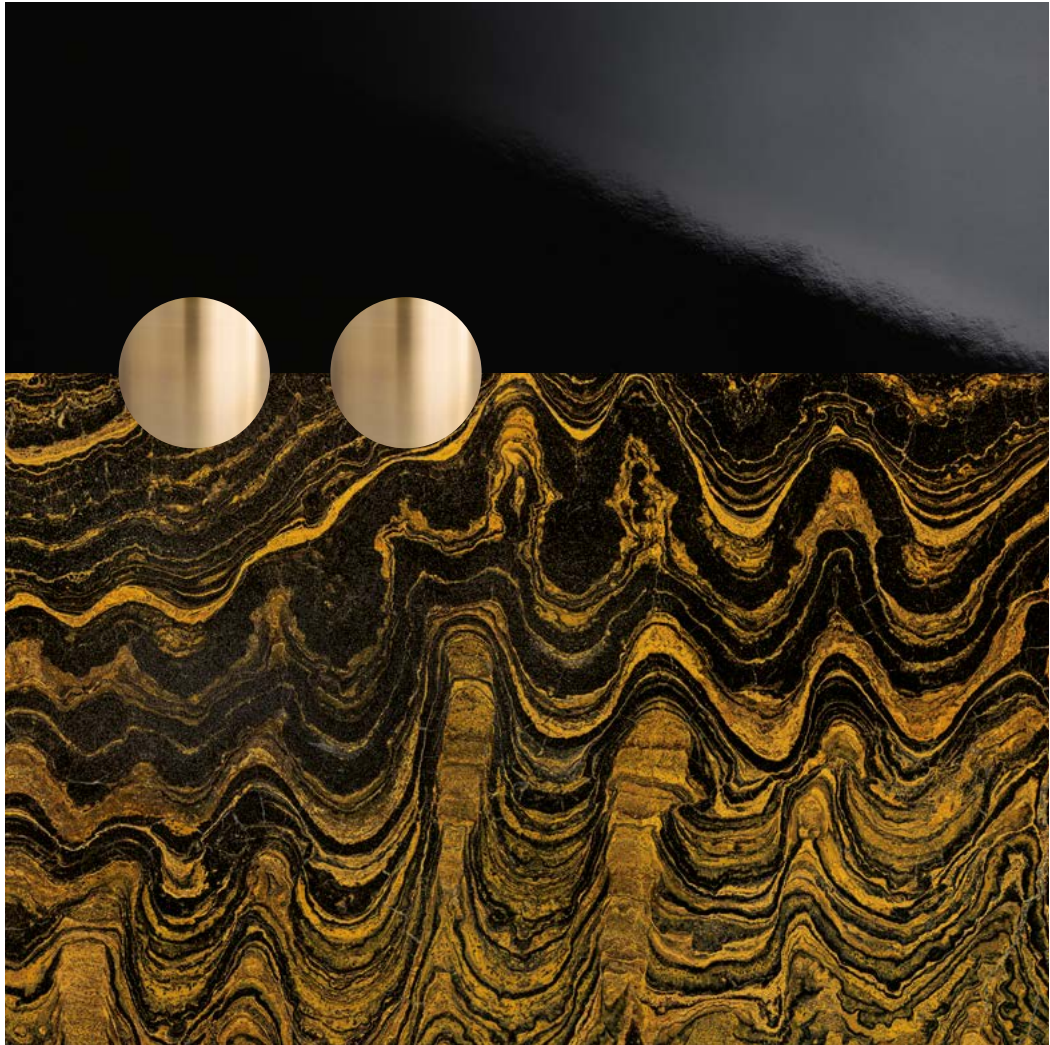



mars_big_M1

vetrite - waves _ legno - laccato nero lucido
vetrite - waves _ wood - glossy black polished



Riconoscere l'autenticità di un prodotto è essenziale, la garanzia che tutto questo è creato in maniera artigianale e con materiali di qualità. Uno speciale sigillo apposto sul tavolo, diventa l'ultimo tocco di elegante ricercatezza di questo oggetto.

Recognizing the authenticity of a product is essential, it guarantees that all it's created in an artisan way and with high-quality materials. A special seal affixed on the table becomes the last touch of elegant sophistication of this object.

mars_big_M1

vetrite - waves _ legno - laccato nero lucido
vetrite - waves _ wood - glossy black polished



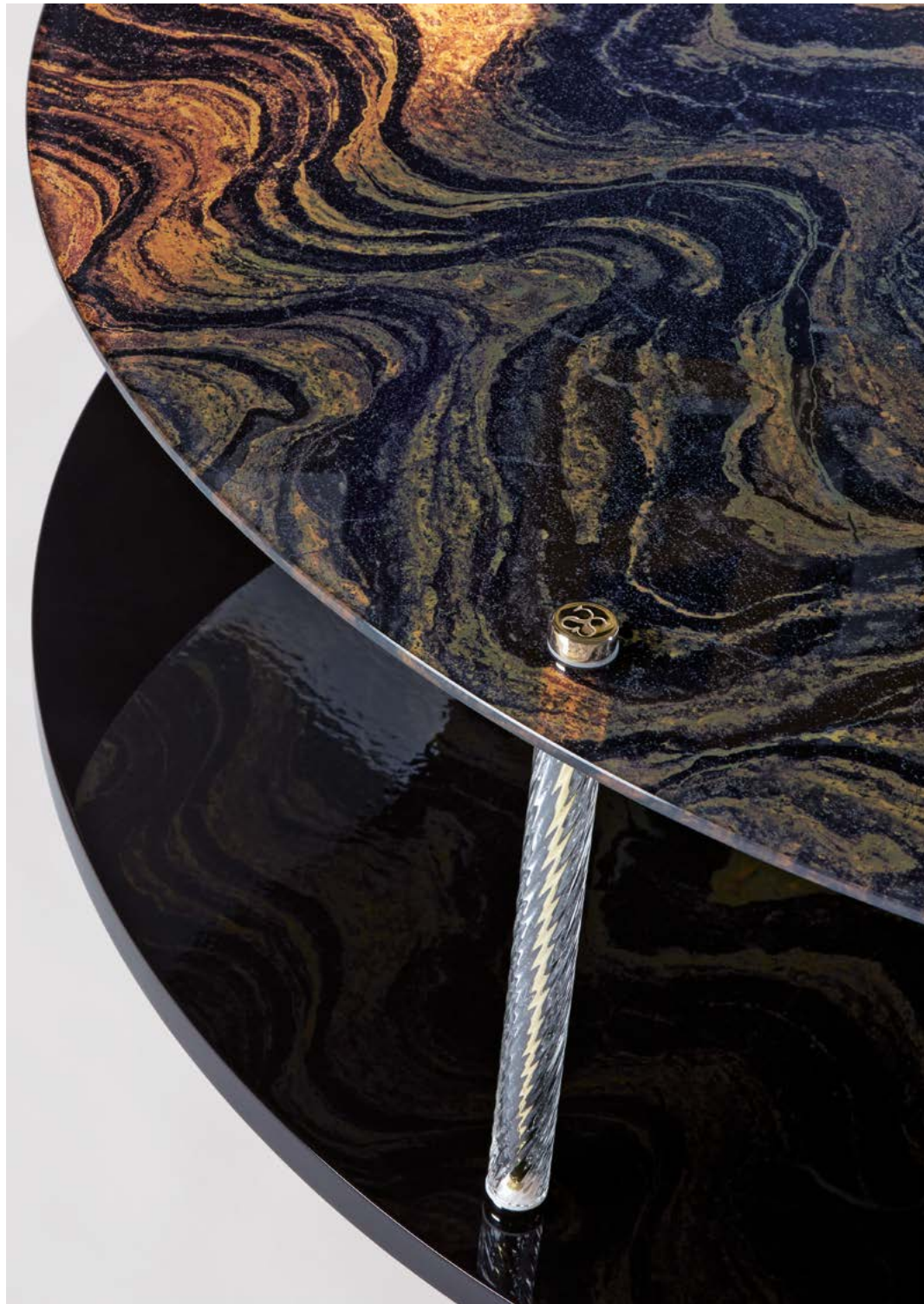

La colonnina in vetro artistico
Un dettaglio per esplorare il legame tra luminosità e creatività.
Una lavorazione artigianale per plasmare la luce attraverso la trasparenza.



Artistic glass rod

A detail made to explore the connection between brightness and creativity.
A handcrafted work created to shape light through transparency.



coffee table big - options

Mars Big_M1 140x95x40 cm_55"x37"x15³/₄"

Vetrite Waves_legno laccato nero lucido
 Vetrite Waves_wood glossy black lacquer



Tavolino con struttura inferiore in legno curvato e Top nelle varianti legno o Vetrite curvati. Inserti metallici in finitura lucida o satinata con inserto di collegamento tra il piano inferiore e il piano superiore in tubo di vetro trasparente decorato.

Coffee table with lower structure in curved wood with top in curved wood or Vetrite. Metal inserts in polished or satin finish connecting insert between lower and upper shelf in decorated transparent glass tube.

Mars Big_M1 in abbinamento con / matched with



Mars Big_M1 140x95x40_55"x37"x15³/₄"

Vetrite Waves_legno laccato nero lucido
 Vetrite Waves_wood glossy black polished



Mars Big_M4 140x75x40_55"x29"x15³/₄"

Legno laccato nero lucido
 Wood glossy black polished

technical data

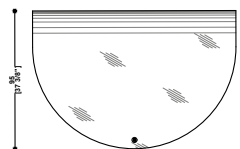
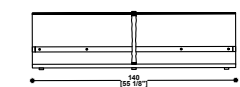

glass - vetro 140x95

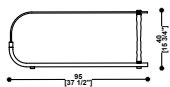
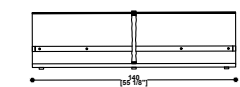

glass - vetro 140x95

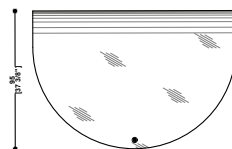
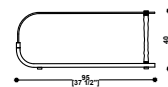
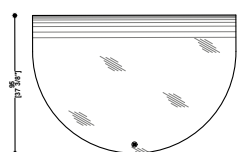

glass - vetro 140x95

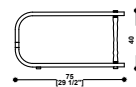

wood - legno 140x75

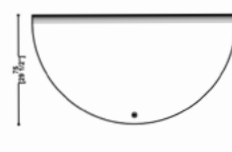

coffee table small - options

Mars Small_M5 110x75x40_43"x29"x15³/₄"

Vetrite Waves_legno laccato nero lucido
 Vetrite Waves_wood glossy black lacquer



Tavolino con struttura inferiore in legno curvato e Top nelle varianti legno o Vetrite curvati. Inserti metallici in finitura lucida o satinata con inserto di collegamento tra il piano inferiore e il piano superiore in tubo di vetro trasparente decorato.

Coffee table with lower structure in curved wood with top in curved wood or Vetrite.
Metal inserts in polished or satin finish connecting insert between lower and upper shelf in decorated transparent glass tube.

Mars Small_M5 in abbinamento con / matched with



Mars Small_M5 110x75x40_43"x29"x15³/₄"

Vetrite Waves_legno laccato nero lucido
 Vetrite Waves_wood glossy black polished



Mars Small_M8 110x55x40_43"x21"x15³/₄"

Legno laccato nero lucido
 Wood glossy black polished

technical data

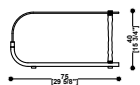
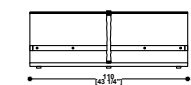

glass - vetro 110x75

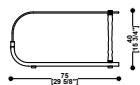
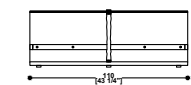
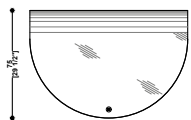

glass - vetro 110x75

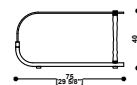
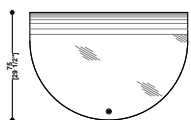

glass - vetro 110x75

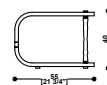
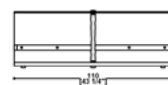
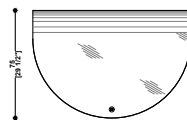

wood - legno 110x55

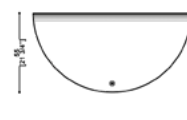



SOLUTION 02

mars_big_140

vetrite - frost _ legno - rovere grigio opaco
vetrite - frost _ wood - matt gray oak

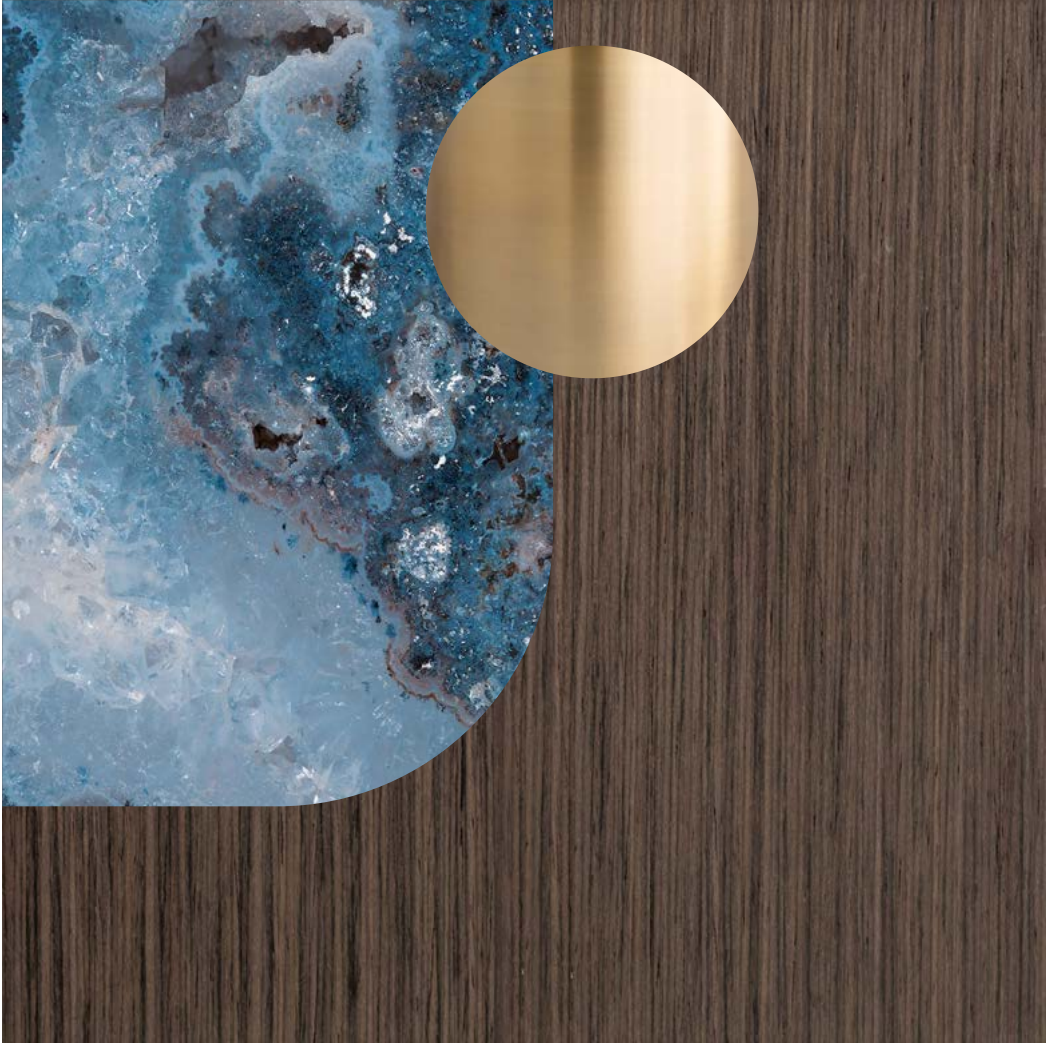







mars_big_M1+M4



coffee table big - options

Mars Big_M1 140x95_55"x37"

Vetrite Frost_legno rovere grigio opaco
 Vetrite Frost_wood matt gray oak

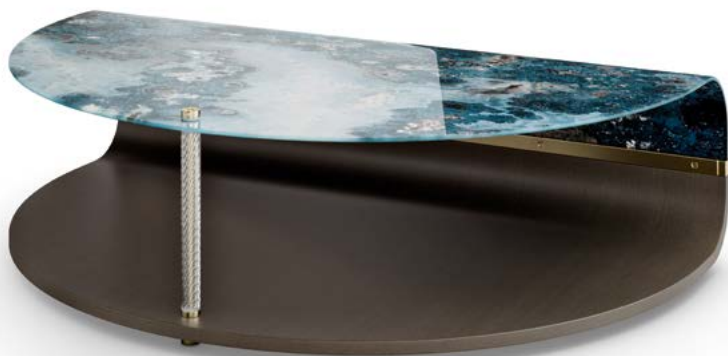

Tavolino con struttura inferiore in legno curvato e Top nelle varianti legno o Vetrite curvati. Inserti metallici in finitura lucida o satinata con inserto di collegamento tra il piano inferiore e il piano superiore in tubo di vetro trasparente decorato.

Coffee table with lower structure in curved wood with top in curved wood or Vetrite. Metal inserts in polished or satin finish connecting insert between lower and upper shelf in decorated transparent glass tube.

Mars Big_M1 in abbinamento con / matched with



Mars Big_M1 140x95_55"x37"

Vetrite Frost_legno rovere grigio opaco
 Vetrite Frost_wood matt gray oak

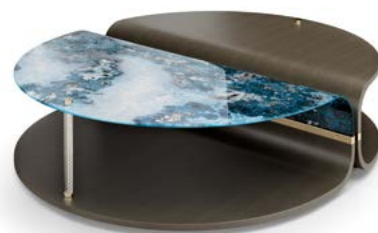

Mars Big_M4 140x75_55"x29"

Legno rovere grigio opaco
 Wood matt gray oak

technical data

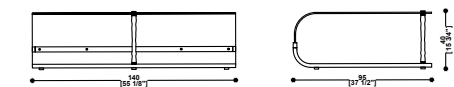

glass - vetro 140x95

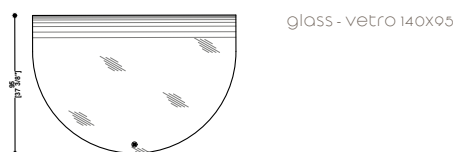
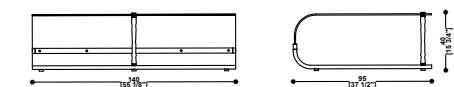

glass - vetro 140x95

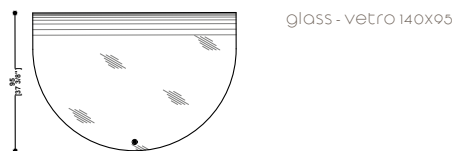
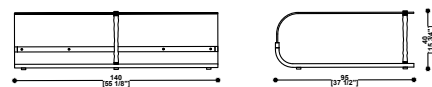

glass - vetro 140x95

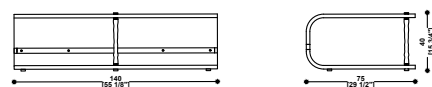

wood - legno 140x75

coffee table small - options

Mars Small_M5 110x75_43"x29"

Vetrite Frost_legno rovere grigio opaco
 Vetríte Frost_wood matt gray oak

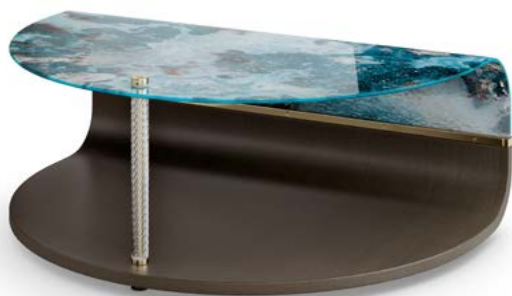

Tavolino con struttura inferiore in legno curvato e Top nelle varianti legno o Vetrite curvati. Inserti metallici in finitura lucida o satinata con inserto di collegamento tra il piano inferiore e il piano superiore in tubo di vetro trasparente decorato.

Coffee table with lower structure in curved wood with top in curved wood or Vetrite. Metal inserts in polished or satin finish connecting insert between lower and upper shelf in decorated transparent glass tube.

Mars Small_M5 in abbinamento con / matched with



Mars Small_M5 110x75_43"x29"

Vetrite Frost_legno rovere grigio opaco
 Vetríte Frost_wood matt gray oak

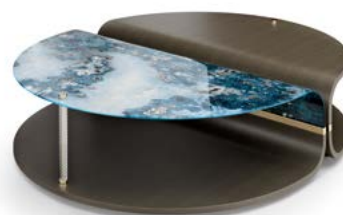

Mars Small_M8 110x55_43"x21"

Legno rovere grigio opaco
 Wood matt gray oak

technical data

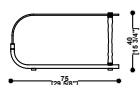

glass - vetro 110x75

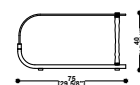
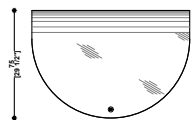

glass - vetro 110x75

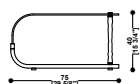
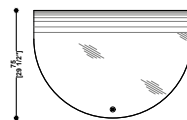

glass - vetro 110x75

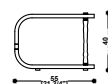
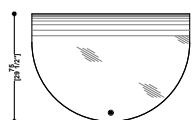

wood - legno 110x55





SOLUTION 03

mars_big_140

vetrite - boulder _ legno - rovere grigio opaco
vetrite - boulder_ wood - matt gray oak









Mars_Big_M1+M1



coffee table big - options

Mars Big_M1 140x95_55"x37"

Vetrite Boulder_legno rovere grigio opaco
 Vetrite Boulder_wood matt gray oak



Tavolino con struttura inferiore in legno curvato e Top nelle varianti legno o Vetrite curvati. Inserti metallici in finitura lucida o satinata con inserto di collegamento tra il piano inferiore e il piano superiore in tubo di vetro trasparente decorato.

Coffee table with lower structure in curved wood with top in curved wood or Vetrite. Metal inserts in polished or satin finish connecting insert between lower and upper shelf in decorated transparent glass tube.

Mars Big_M1 in abbinamento con / matched with



Mars Big_M1 140x95_55"x37"

Vetrite Boulder_legno rovere grigio opaco
 Vetrite Boulder_wood matt gray oak



Mars Big_M4 140x75_55"x29"

Legno rovere grigio opaco
 Wood matt gray oak

technical data

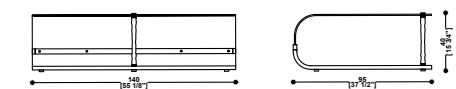

glass - vetro 140x95

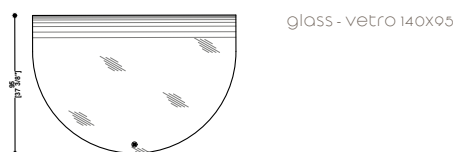
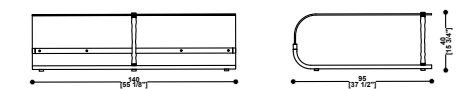

glass - vetro 140x95

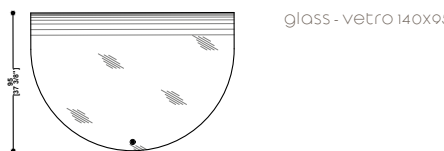
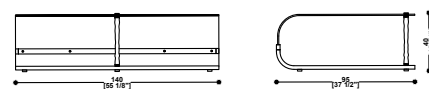

glass - vetro 140x95

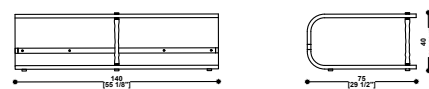

wood - legno 140x75

coffee table small - options

Mars Small_M5 110x75_43"x29"

Vetrite Boulder_legno rovere grigio opaco
 Vetrite Boulder_wood matt gray oak



Tavolino con struttura inferiore in legno curvato e Top nelle varianti legno o Vetrite curvati. Inserti metallici in finitura lucida o satinata con inserto di collegamento tra il piano inferiore e il piano superiore in tubo di vetro trasparente decorato.

Coffee table with lower structure in curved wood with top in curved wood or Vetrite. Metal inserts in polished or satin finish connecting insert between lower and upper shelf in decorated transparent glass tube.

Mars Small_M5 in abbinamento con / matched with

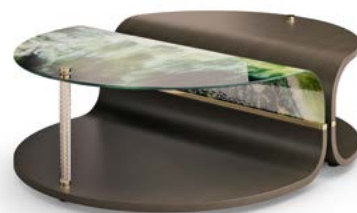

Mars Small_M5 110x75_43"x29"

Vetrite Boulder_legno rovere grigio opaco
 Vetrite Boulder_wood matt gray oak

Mars Small_M8 110x55_43"x21"

Legno rovere grigio opaco
 Wood matt gray oak

technical data

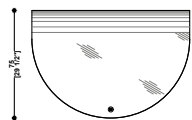
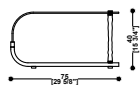

glass - vetro 110x75

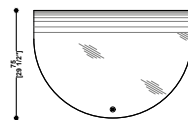
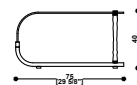

glass - vetro 110x75

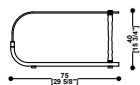

glass - vetro 110x75

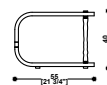

wood - legno 110x55

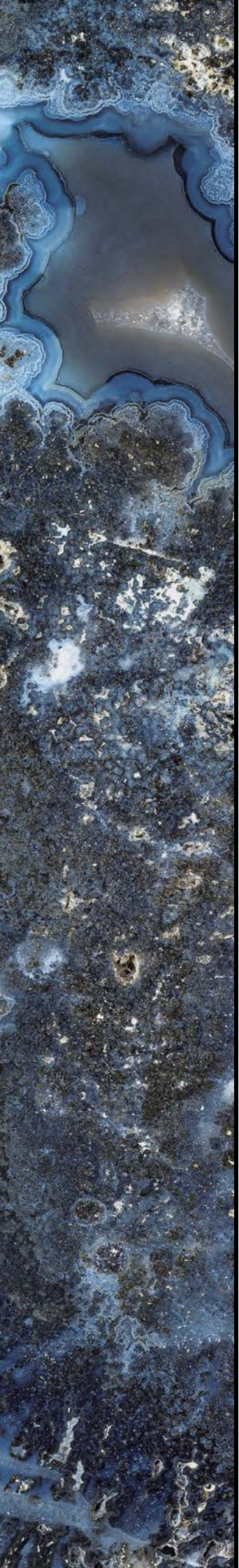

SOLUTION 04

mars_big_140

vetrite - neve _ legno - ebano macassar lucido
vetrite - neve_ wood - ebony macassar shiny

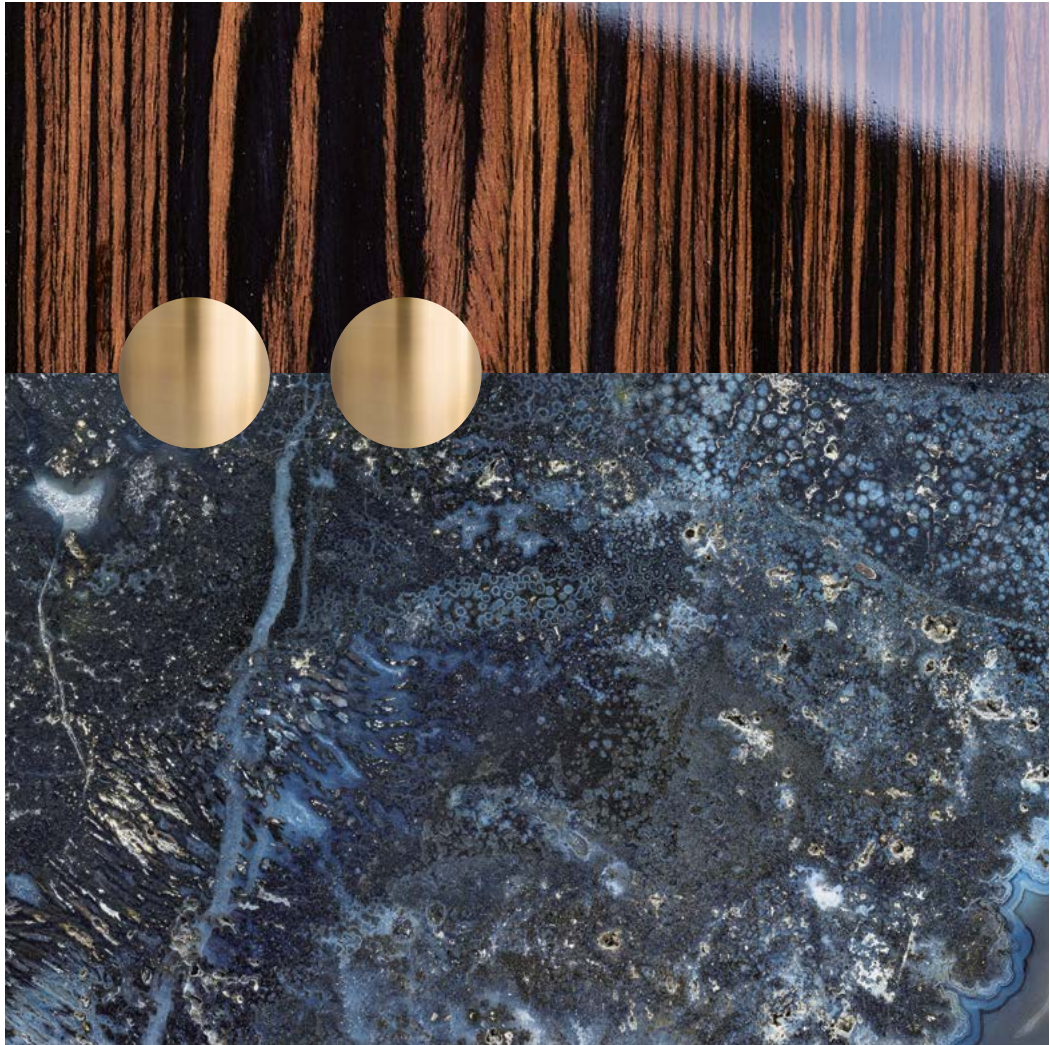







mars_big_M1+M4



coffee table big - options

Mars Big_M1 140x95_55"x37"

Vetrite Neve_legno ebano macassar lucido
Vetrite Neve_wood ebony macassar shiny

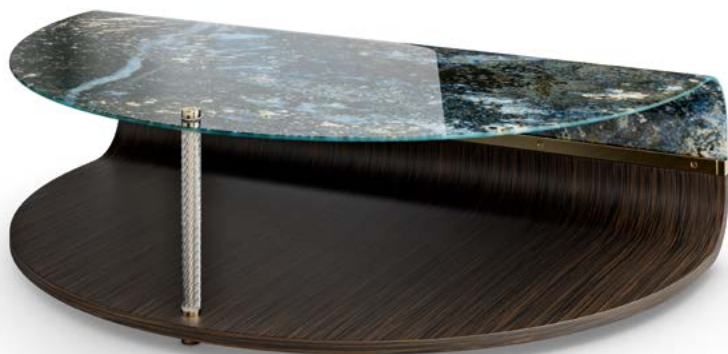

Tavolino con struttura inferiore in legno curvato e Top nelle varianti legno o Vetrite curvati. Inserti metallici in finitura lucida o satinata con inserto di collegamento tra il piano inferiore e il piano superiore in tubo di vetro trasparente decorato.

Coffee table with lower structure in curved wood with top in curved wood or Vetrite. Metal inserts in polished or satin finish connecting insert between lower and upper shelf in decorated transparent glass tube.

Mars Big_M1 in abbinamento con / matched with



Mars Big_M1 140x95_55"x37"

Vetrite Neve_legno ebano macassar lucido
Vetrite Neve_wood ebony macassar shiny



Mars Big_M4 140x75_55"x29"

Legno ebano macassar lucido
Wood ebony macassar shiny

technical data

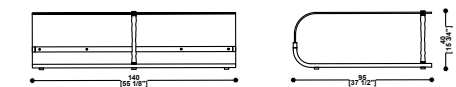

glass - vetro 140x95

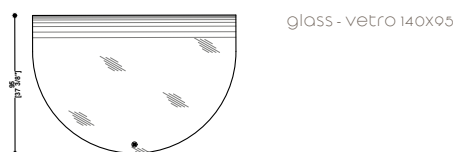
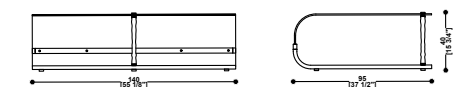

glass - vetro 140x95

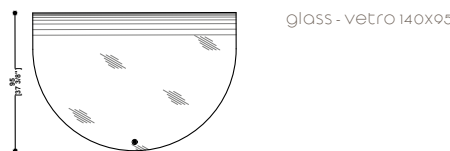
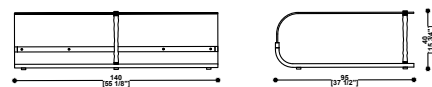

glass - vetro 140x95

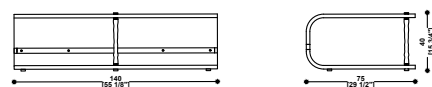

wood - legno 140x75

coffee table small - options

Mars Small_M5 110x75_43"x29"

Vetrite Neve_legno ebano macassar lucido
Vetrite Neve_wood ebony macassar shiny



Tavolino con struttura inferiore in legno curvato e Top nelle varianti legno o Vetrite curvati. Inserti metallici in finitura lucida o satinata con inserto di collegamento tra il piano inferiore e il piano superiore in tubo di vetro trasparente decorato.

Coffee table with lower structure in curved wood with top in curved wood or Vetrite. Metal inserts in polished or satin finish connecting insert between lower and upper shelf in decorated transparent glass tube.

Mars Small_M5 in abbinamento con / matched with



Mars Small_M5 110x75_43"x29"

Vetrite Neve_legno ebano macassar lucido
Vetrite Neve_wood ebony macassar shiny

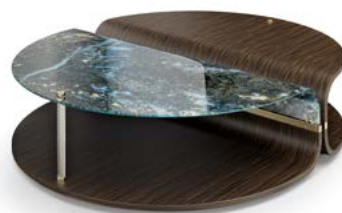

Mars Small_M8 110x55_43"x21"

Legno ebano macassar lucido
Wood ebony macassar shiny

technical data

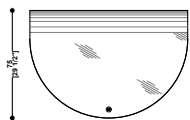
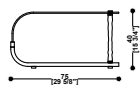

glass - vetro 110x75

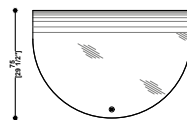
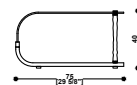

glass - vetro 110x75

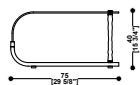

glass - vetro 110x75

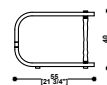

wood - legno 110x55



SOLUTION 05

mars_big_140

vetrite - lignin _ legno - ebano macassar lucido
vetrite - lignin_ wood - ebony macassar shiny

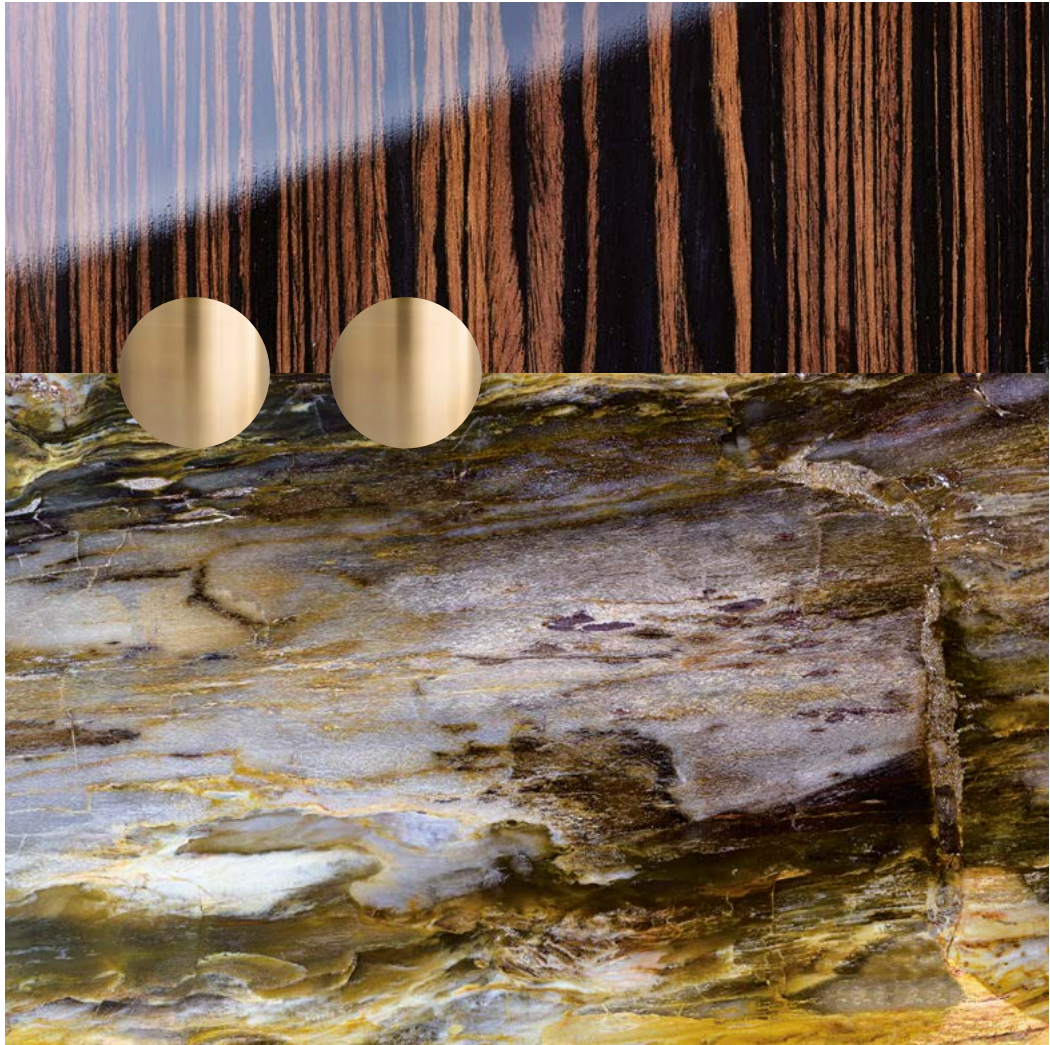









mars_big_M1+M1

vetrite - lignin _ legno - ebano macassar lucido
vetrite - lignin_ wood - ebony macassar shiny



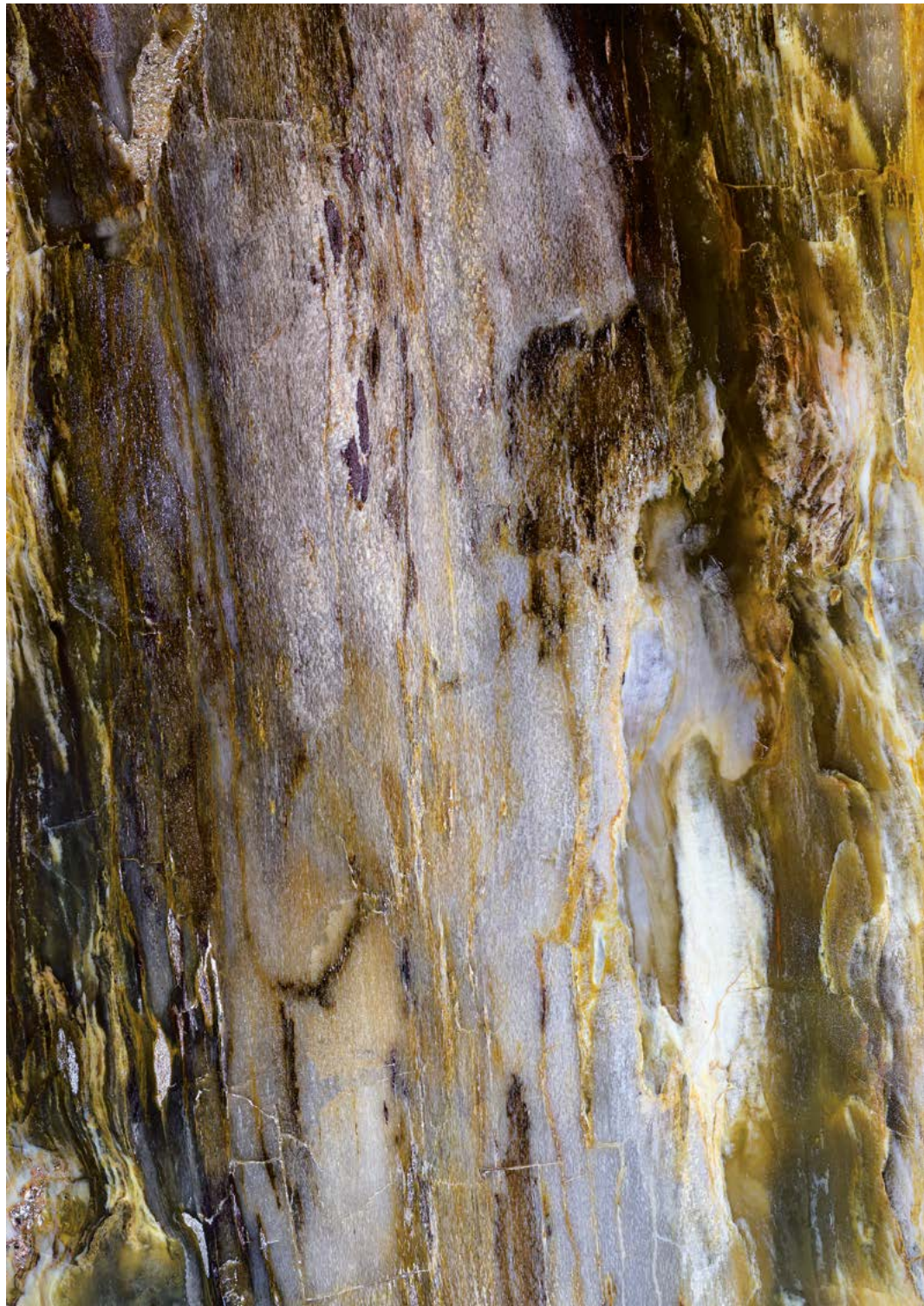

coffee table big - options

Mars Big_M1 140x95_55"x37"

Vetrite Lignin_legno ebano macassar lucido
Vetrite Lignin_wood ebony macassar shiny



Tavolino con struttura inferiore in legno curvato e Top nelle varianti legno o Vetrite curvati. Inserti metallici in finitura lucida o satinata con inserto di collegamento tra il piano inferiore e il piano superiore in tubo di vetro trasparente decorato.

Coffee table with lower structure in curved wood with top in curved wood or Vetrite. Metal inserts in polished or satin finish connecting insert between lower and upper shelf in decorated transparent glass tube.

Mars Big_M1 in abbinamento con / matched with



Mars Big_M1 140x95_55"x37"

Vetrite Lignin_legno ebano macassar lucido
Vetrite Lignin_wood ebony macassar shiny



Mars Big_M4 140x75_55"x29"

Legno ebano macassar lucido
Wood ebony macassar shiny

technical data

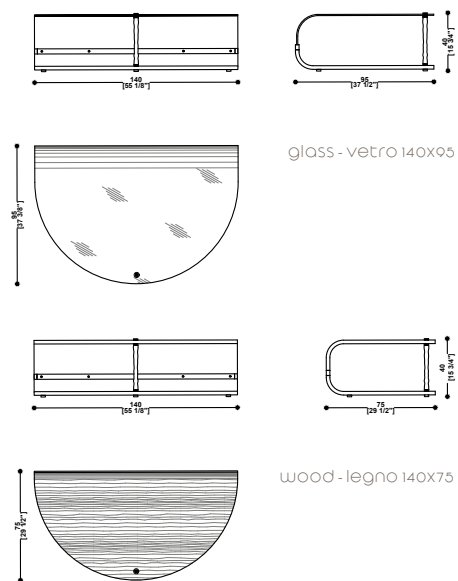
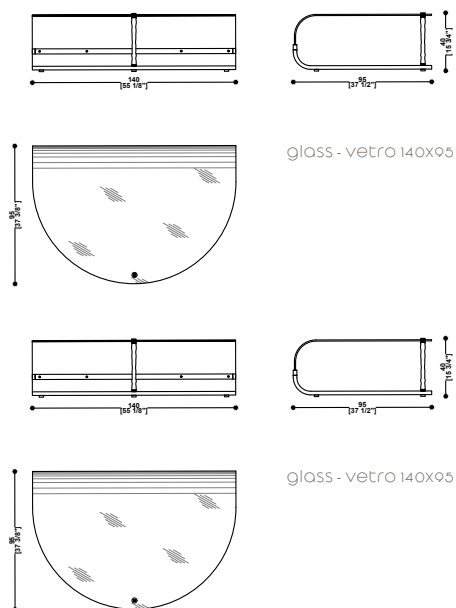

coffee table small - options

Mars Small_M5 110x75_43"x29"

Vetrite Lignin_legno ebano macassar lucido
Vetrite Lignin_wood ebony macassar shiny



Tavolino con struttura inferiore in legno curvato e Top nelle varianti legno o Vetrite curvati. Inserti metallici in finitura lucida o satinata con inserto di collegamento tra il piano inferiore e il piano superiore in tubo di vetro trasparente decorato.

Coffee table with lower structure in curved wood with top in curved wood or Vetrite. Metal inserts in polished or satin finish connecting insert between lower and upper shelf in decorated transparent glass tube.

Mars Small_M5 in abbinamento con / matched with



Mars Small_M5 110x75_43"x29"

Vetrite Lignin_legno ebano macassar lucido
Vetrite Lignin_wood ebony macassar shiny

Mars Small_M8 110x55_43"x21"

Legno ebano macassar lucido
Wood ebony macassar shiny

technical data

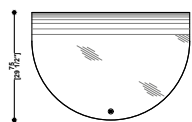
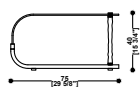
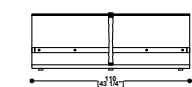

glass - vetro 110x75

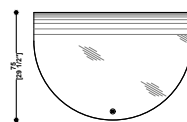
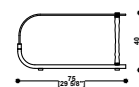

glass - vetro 110x75

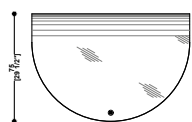
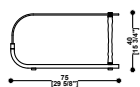
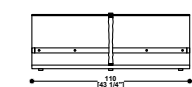

glass - vetro 110x75

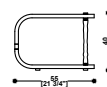

wood - legno 110x55

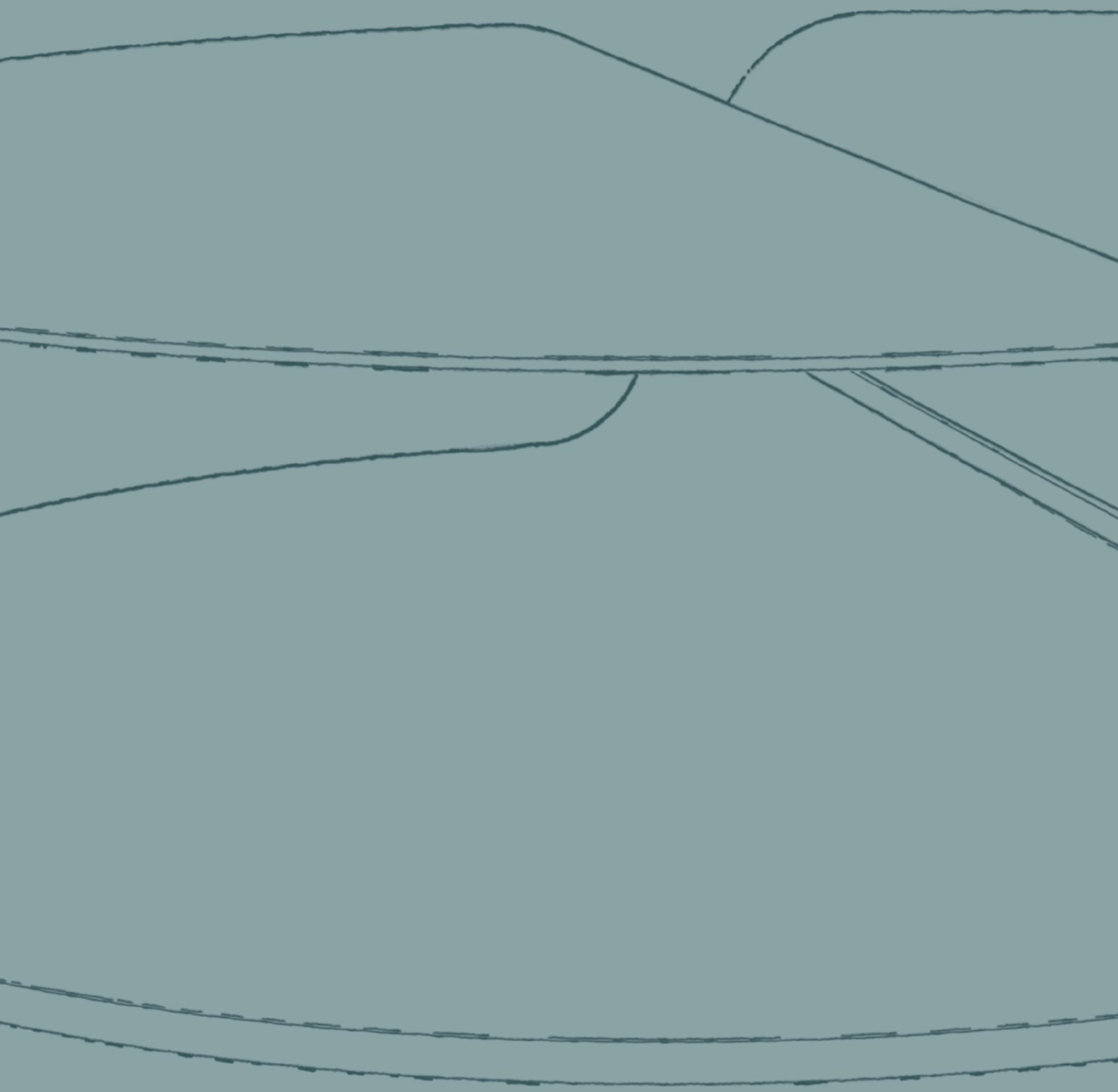

mars_small 110_{cm.}

coffee table

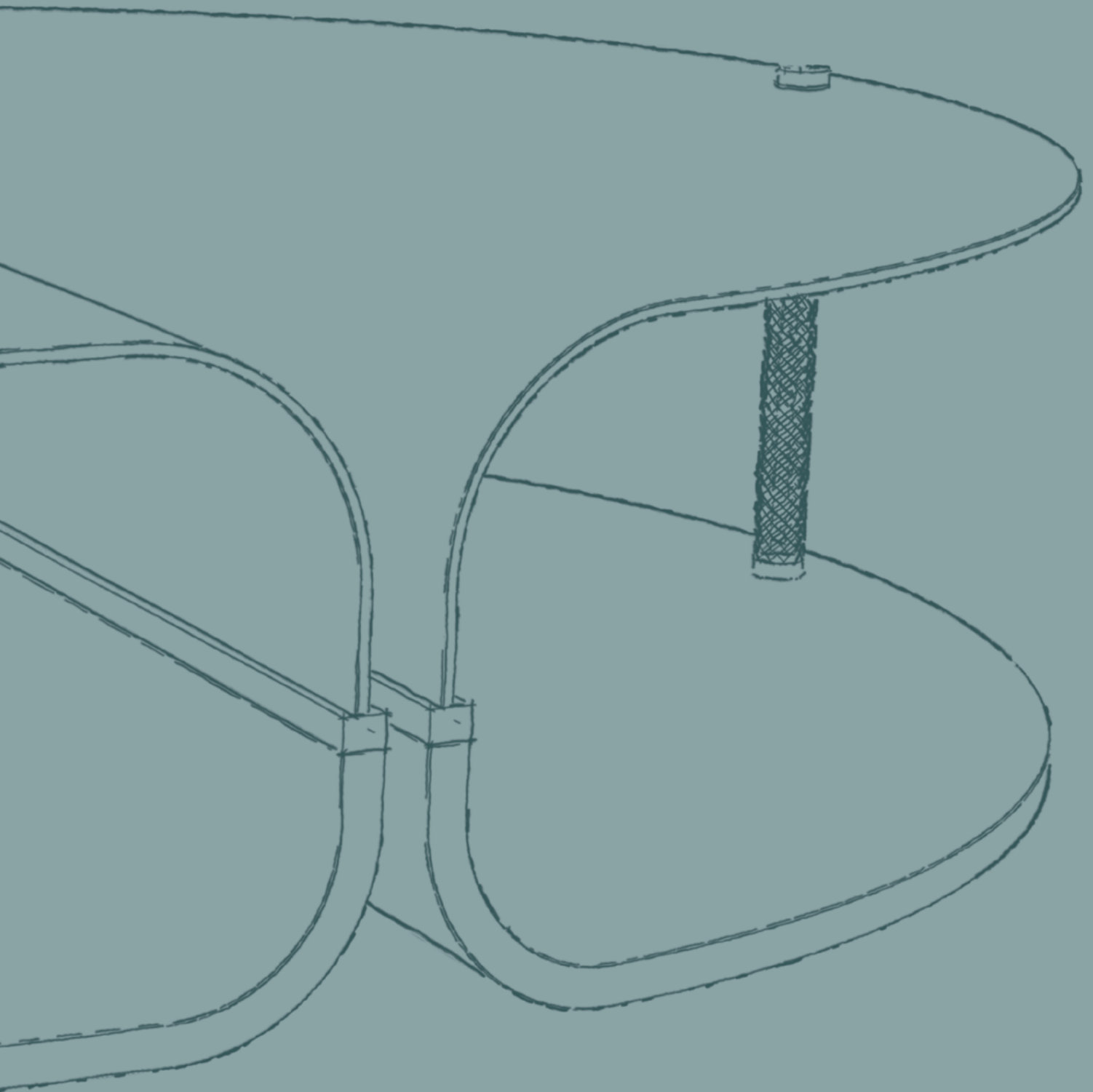



SOLUTION 06

mars_small_110

vetrite - grain _ legno - laccato avorio lucido
vetrite - grain_ wood - ivory lacquer shiny

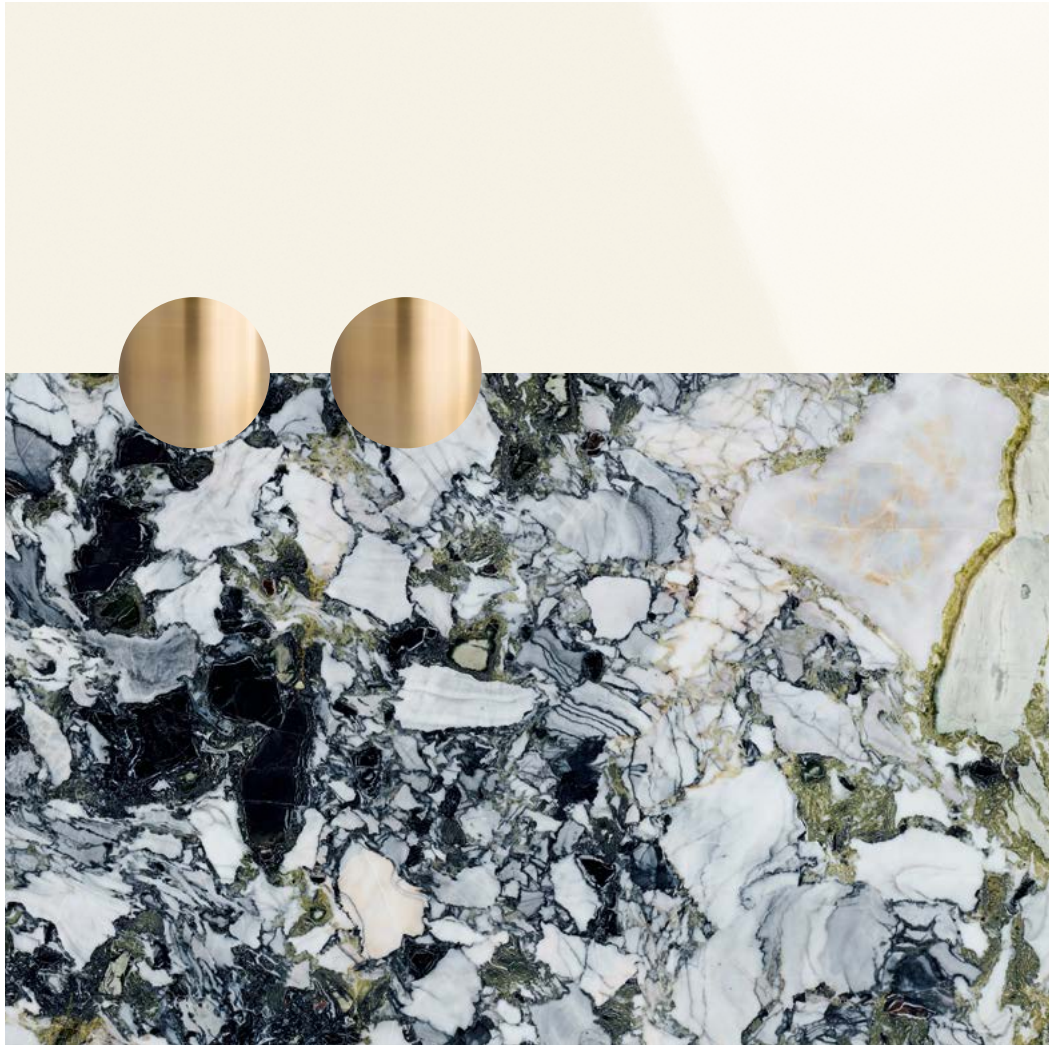









mars_small_M5+M8

vetrite - grain_ legno - laccato avorio lucido
vetrite - grain_ wood - ivory lacquer shiny





coffee table big - options

Mars Big_M1 140x95_55"x37"

Vetrite Grain_legno laccato avorio lucido
Vetrite Grain_wood ivory lacquer shiny

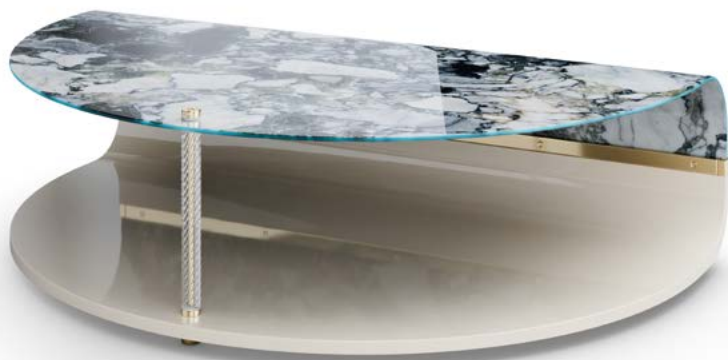

Tavolino con struttura inferiore in legno curvato e Top nelle varianti legno o Vetrite curvati. Inserti metallici in finitura lucida o satinata con inserto di collegamento tra il piano inferiore e il piano superiore in tubo di vetro trasparente decorato.

Coffee table with lower structure in curved wood with top in curved wood or Vetrite.
Metal inserts in polished or satin finish connecting insert between lower and upper shelf in decorated transparent glass tube.

Mars Big_M1 in abbinamento con / matched with



Mars Big_M1 140x95_55"x37"

Vetrite Grain_legno laccato avorio lucido
Vetrite Grain_wood ivory lacquer shiny



Mars Big_M4 140x75_55"x29"

Legno laccato avorio lucido
Wood ivory lacquer shiny

technical data

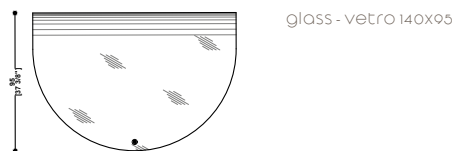
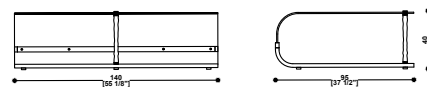
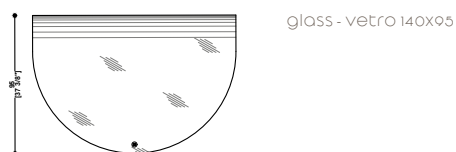
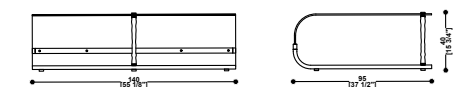
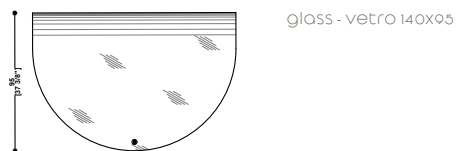
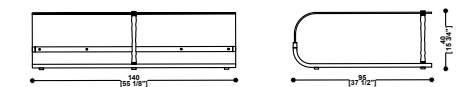

coffee table small - options

Mars Small_M5 110x75_43"x29"

Vetrite Grain_legno laccato avorio lucido
Vetrite Grain_wood ivory lacquer shiny

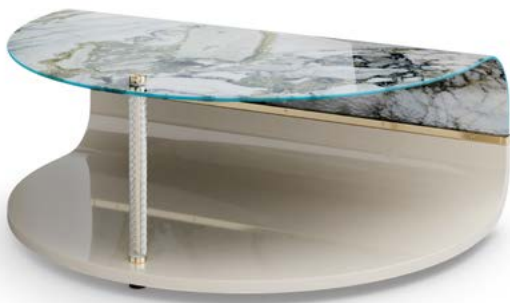

Tavolino con struttura inferiore in legno curvato e Top nelle varianti legno o Vetrite curvati. Inserti metallici in finitura lucida o satinata con inserto di collegamento tra il piano inferiore e il piano superiore in tubo di vetro trasparente decorato.

Coffee table with lower structure in curved wood with top in curved wood or Vetrite.
Metal inserts in polished or satin finish connecting insert between lower and upper shelf in decorated transparent glass tube.

Mars Small_M5 in abbinamento con / matched with



Mars Small_M5 110x75_43"x29"

Vetrite Grain_legno laccato avorio lucido
Vetrite Grain_wood ivory lacquer shiny



Mars Small_M8 110x55_43"x21"

Legno laccato avorio lucido
Wood ivory lacquer shiny

technical data

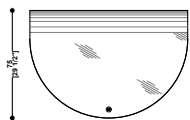
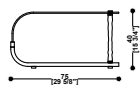

glass - vetro 110x75

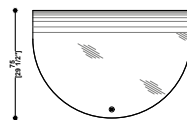
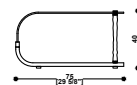

glass - vetro 110x75

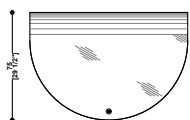
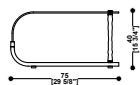
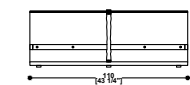

glass - vetro 110x75

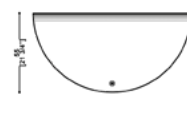
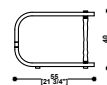
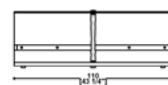

wood - legno 110x55

mars big - codici/codes

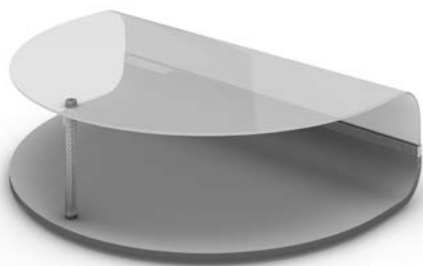

Mars Big_M1
140x95 - vetro/legno _ 55"x37" - glass/wood

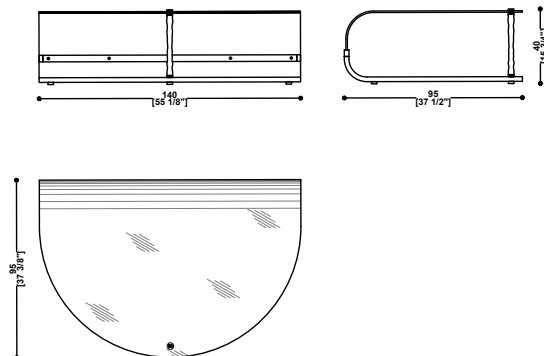

Mars Big_M2
140x95 - legno/legno _ 55"x37" - wood/wood

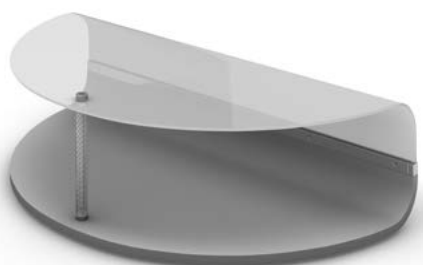
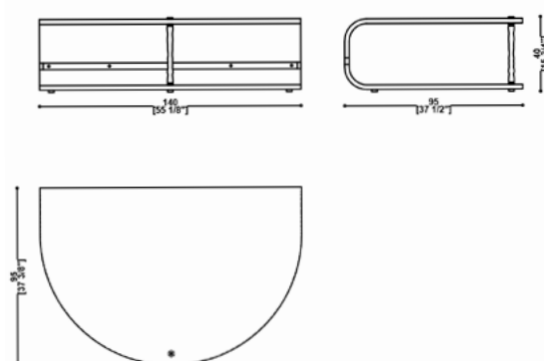

Mars Big_M3
140x75 - vetro/legno _ 55"x29" - glass/wood

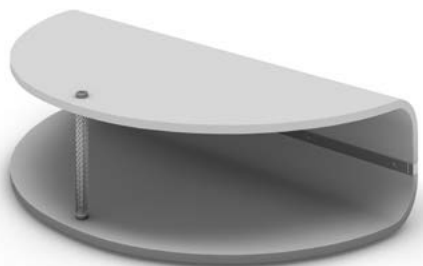
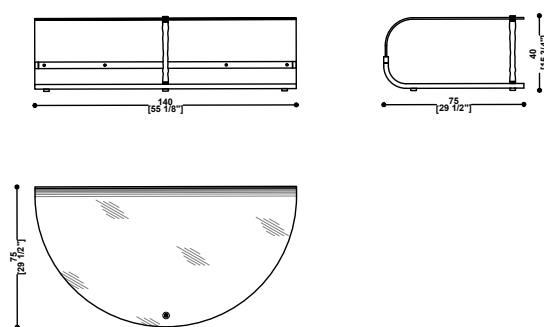

Mars Big_M4
140x75 - legno/legno _ 55"x29" - wood/wood

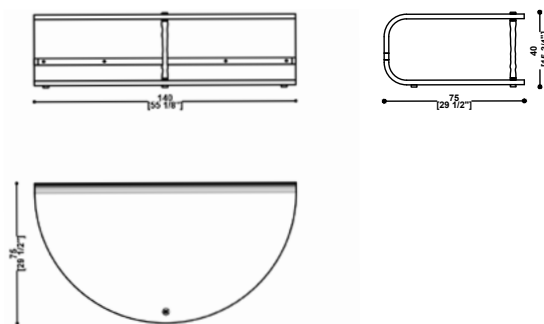

mars small - codici/codes

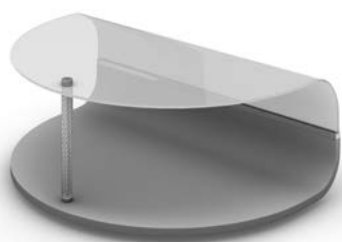

Mars Small _ M5
110x75 - vetro/legno _ 43"x29" - glass/wood

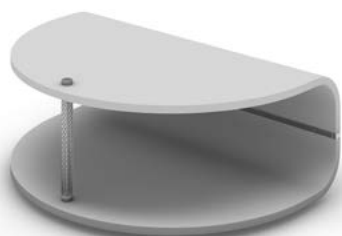
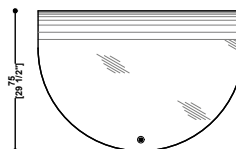
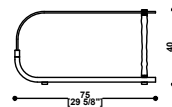
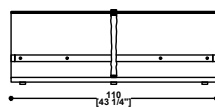

Mars Small _ M6
110x75 - legno/legno _ 43"x29" - wood/wood

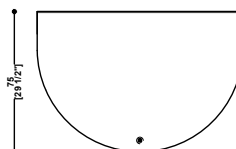
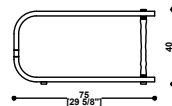
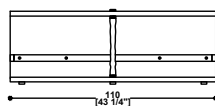

Mars Big _ M7
110x55 - vetro/legno _ 43"x21" - glass/wood

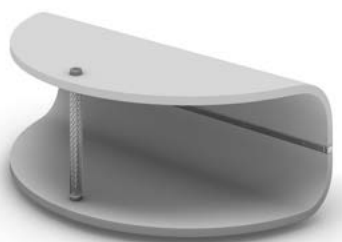
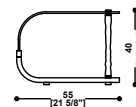
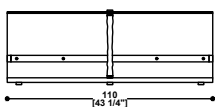

Mars Small _ M8
110x55 - legno/legno _ 43"x21" - wood/wood

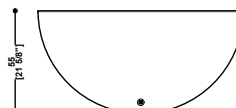
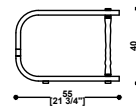
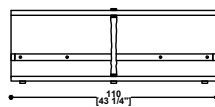

mars big - finiture/finishing

mars big



structure finish lacquer, metal, oak

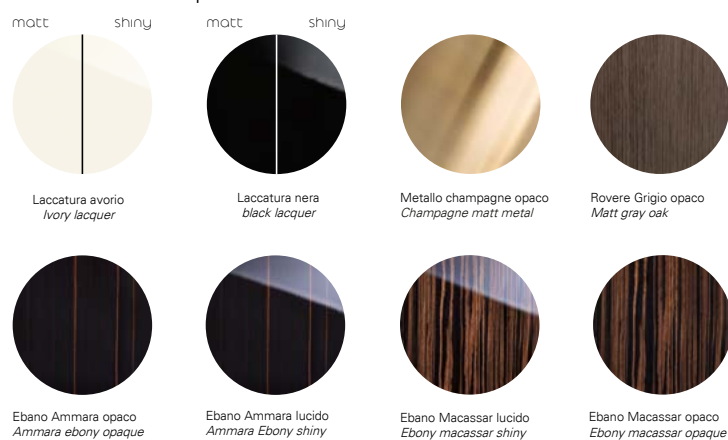

mars big - M1 140X95X40 cm

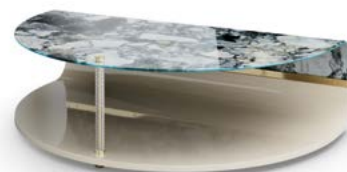
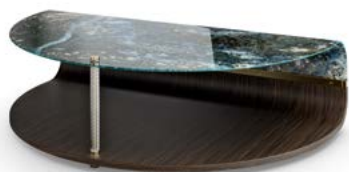
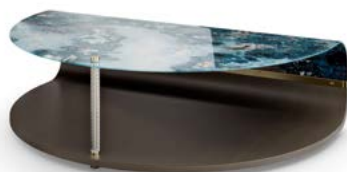

La varietà delle tre tipologie di legni (rovere, macassar, ebano) e le infinite possibilità di laccature RAL su richiesta.

Materiali pregiati e concreti, per personalizzare ogni minima finitura.

The multiplicity of three types of woods (oak, macassar, ebony) and the infinite possibilities of RAL lacquering upon request.

Precious and concrete materials, to customize even the smallest detail.

mars small - finiture/finishing

mars small



structure finish lacquer, metal, oak

| | | | | | | | |
|--|--|--|--|--|--|--|--|
| matt | | shiny | | matt | | shiny | |
| | | | | | | | |
| Laccatura avorio <i>Ivory lacquer</i> | | Laccatura nera <i>black lacquer</i> | | Metallo champagne opaco <i>Champagne matt metal</i> | | Rovere Grigio opaco <i>Matt gray oak</i> | |
| | | | | | | | |
| Ebano Ammara opaco <i>Ammara Ebony opaque</i> | | Ebano Ammara lucido <i>Ammara Ebony shiny</i> | | Ebano Macassar lucido <i>Ebony macassar shiny</i> | | Ebano Macassar opaco <i>Ebony macassar opaque</i> | |

mars small - M5 110X75X40 cm.

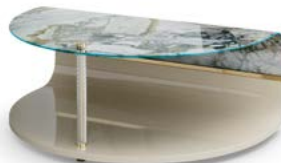
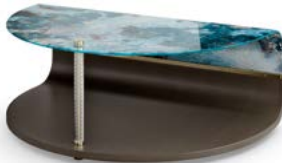

mars big and small - diffuser glass finish

VETRITE GEM GLASS

Agata Blue



Agata Lilla



Aurora



Bloomer



Boulder



Canyon



Cave



Fable



Frost



Galaxy



Grain



Ignite

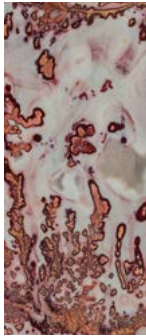

Lagoon



Lake



Punctum

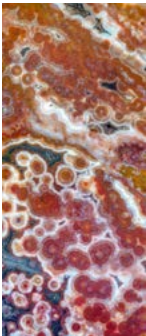

Reef



River

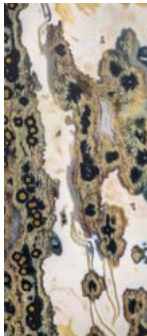

Rock



Sepia



Solferino



Sunburst



Chroma



Cliff



Clouds

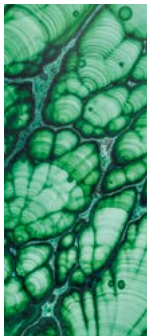

Corundum



Crater

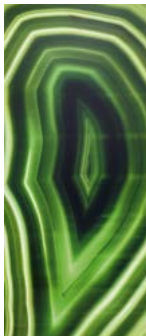

Crimson



Crystallised



Le fantasie di Vetrite GemGlass, dalle nuance affascinanti, sono state selezionate da esperti gemmologi tra tagli di pietre ricercate. Per realizzare il tavolo Mars si possono scegliere le gemme che meglio interpretano il nostro gusto personale.

Gem Glass fascinating nuances have been selected by experts gemologists from precious stones cuts. To create the Mars table, you can pick the gem that best interprets your taste.

Landscape



Lignin



Magma

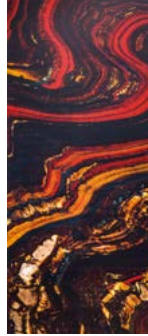

Mahogany



Neve



Pangea Red A



Pangea Red B



Terrain



Unakite

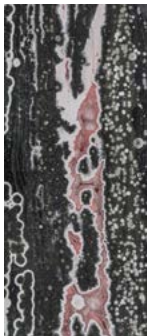

Vulcano



Waves



VETRITE ELECTRIC MARBLE

Gold



Fuxia



Natural



Turchese

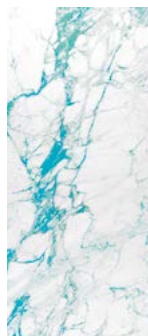

mars big and small - diffuser glass finish

La collezione è molto ricca, i 16 pattern sono stati elaborati a mano e poi rielaborati al computer, poi nuovamente graficizzati. Lo Studio Piva è partito da semplici grafie, fotografie, lavorazioni ad acquerello o a tempera che richiamano le macchie di Rorschach.

The collection is very rich, the 16 patterns have been designed by hand and then elaborated with a computer, then newly turned into graphic. Studio Piva started from simple glyphs, photographs, watercolour or tempera works that remind Rorschach inkblots.

VETRITE SIGHT COLLECTION

Accra 01



Accra 02

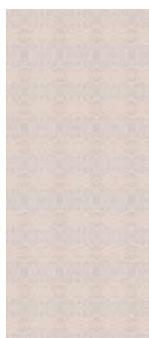

Dubai 01



Hanoi 01



Hanoi 02



Hanoi 02 B&N

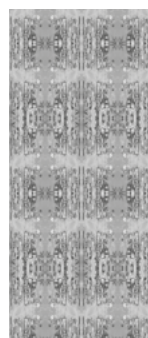

Los Angeles 01



Los Angeles 02



Milano 01



Milano 02



Roma 01



Roma 02



Shanghai 01



Shanghai 02



Venezia 01



Venezia 02





Vetrite Shanghai 02_ legno laccato avorio lucido
Vetrite Shanghai 02_wood ivory lacquer shiny

AVVISO LEGALE

Ricevendo il presente catalogo SICIS, prendi atto ed accetti i seguenti termini e condizioni:

Il presente catalogo è e rimane di proprietà di SICIS S.r.l. ("SICIS").

SICIS si riserva il diritto, in qualsiasi momento, di richiederne la restituzione. Il catalogo è fornito a TITOLO GRATUITO e NON ne è AUTORIZZATA LA RIVENDITA. Se hai dovuto pagare per questo catalogo, ti preghiamo di segnalarcelo scrivendoci all'indirizzo riportato di seguito.

Le leggi in materia di diritto d'autore (Copyright) proteggono il contenuto del presente catalogo, inclusi, senza alcuna limitazione, le fotografie, immagini, testi, layout ed i disegni in esso contenuti.

La riproduzione o la copia di qualsiasi parte del presente catalogo, inclusi, senza alcuna limitazione, le fotografie, immagini, testi, layout ed i disegni in esso contenuti, È VIETATA, e SICIS si riserva il diritto di intraprendere azione legale nei confronti di chiunque (incluso te) violi il presente divieto.

L'aver ricevuto una copia del presente catalogo, non dà diritto in alcun modo ad alcuna licenza da parte di SICIS, né implicita né tantomeno espressa, di riprodurre o copiare, in qualsiasi modo o forma, alcuna parte di esso.

Il marchio SICIS® è un marchio registrato e di proprietà della SICIS S.r.l., ed è protetto dalle leggi nazionali ed internazionali in materia.

SICIS espressamente si riserva tutti i diritti e rimedi.

LEGAL NOTICE

By retaining this SICIS catalogue, you acknowledge and agree to the following:

This catalogue is and remains the property of SICIS S.r.l. ("SICIS").

SICIS reserves the right, at any time, to request the return of this catalogue. The catalogue is provided to you FREE OF CHARGE and is NOT FOR RESALE. If you paid for this catalogue, please write to SICIS at the address provided below.

Copyright laws protect the content of this catalogue, including, without limitation, the photographs, images, text, layout and designs contained therein.

The reproduction or copying of any part of this catalogue, including, without limitation, the photographs, images, text, layout and designs contained therein, IS PROHIBITED, and legal action may be commenced against anyone, including, but not limited to, yourself, who violates this prohibition.

By giving you a copy of this catalogue, SICIS is not thereby giving you any license, either implied or express, to reproduce or copy it or any parts of it, in any way.

The trademark SICIS® is a registered trademark and the property of SICIS S.r.l., and is protected under domestic and international laws.

SICIS reserves all its rights and remedies.

www.sicis.com · info@sicis.com

SICIS · Sede Legale · Via Borgonuovo, 29 · 20121 Milano (Italy)

Sicis s.r.l. Ravenna (Italy) - April 2022

© 2020-2021-2022 Sicis S.r.l.

SICIS® is trademark of Sicis S.r.l. _ *SICIS® è un marchio di Sicis S.r.l.*

SICIS ITALY

Showroom Milano

20121 · Via Fatebenefratelli, 8

Ph. +39 02 87 60 99 · Fax +39 02 72 09 68 53

Showroom & Factory Ravenna (Italy)

48123 · Via Canala, 85

Ph. +39 0544 469 711 · Fax +39 0544 46 98 11

SICIS FRANCE

Showroom Paris

75008 · 41, Rue François 1er

Ph. +33 (0)1 4952 8989 · Fax +33 (0)1 4952 8990

SICIS SPAIN

Showroom Madrid

28006 · 33, calle José Ortega y Gasset

Ph. +34 910572844

SICIS UNITED KINGDOM

Showroom & Offices London

15A Dover St, Mayfair, W1S 4LR

Ph. +44 207 491 9849

SICIS TESSERA INDIA

Showroom New Delhi

Unit No. 356/357, M-G Road, Sultanpur

Delhi 110030

Mob. +1 800 120 2249

SICIS NORTH AMERICA

Corporate Headquarters New York

10454 · 150 Bruckner Blvd Bronx

Ph. +1 212 965 4100 · Fax +1 646 390 4587

SICIS®

www.sicis.com
made in Italy

