

SICIS®  
HOME COLLECTION

Gemma

ceiling lamp

ROUND\_RING

MADE IN ITALY

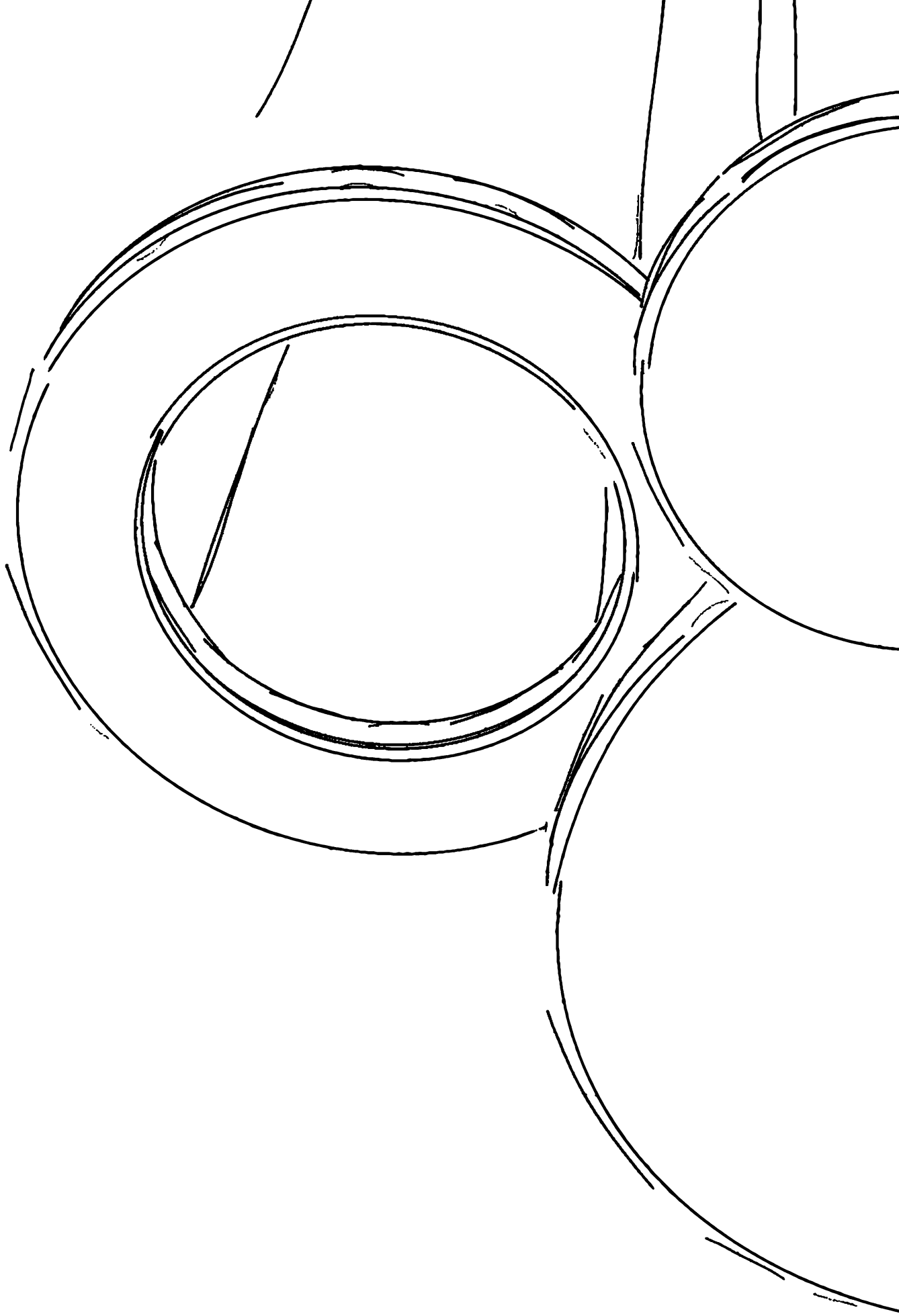



# Gemma

ceiling lamp

designed by Massimiliano Raggi

ROUND\_RING

Uno show di luce e materia  
*A show of light and matter*





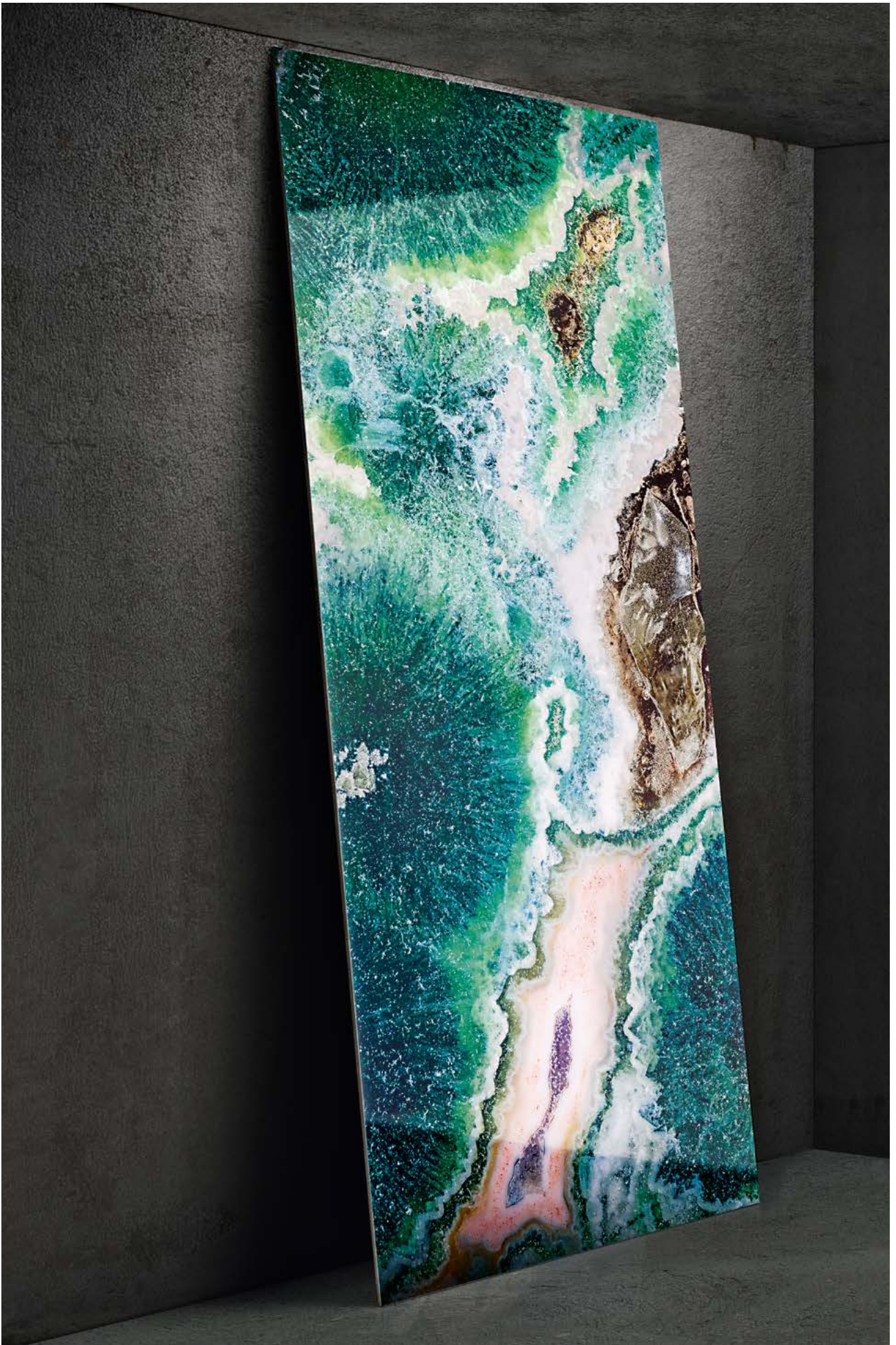













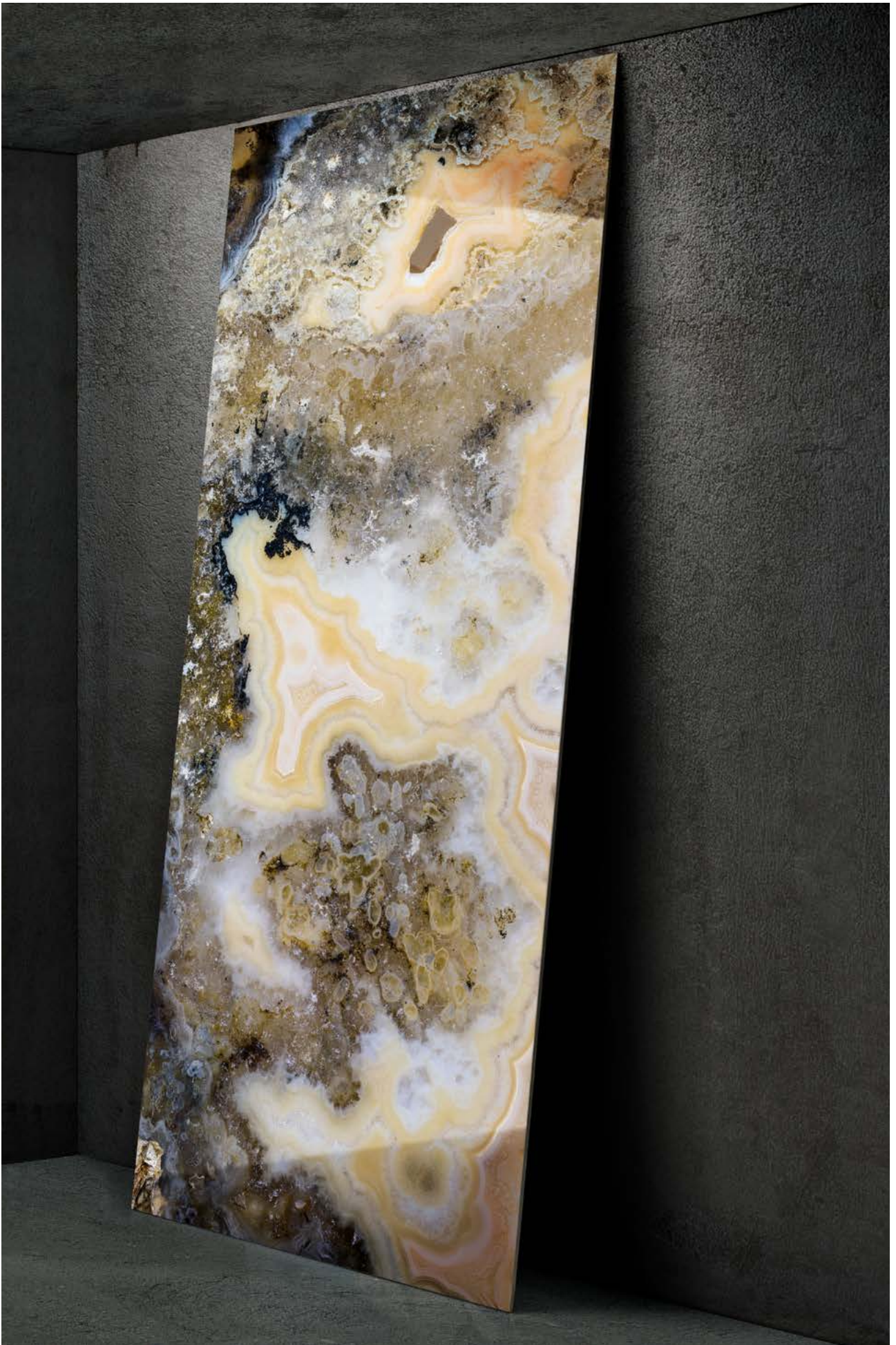



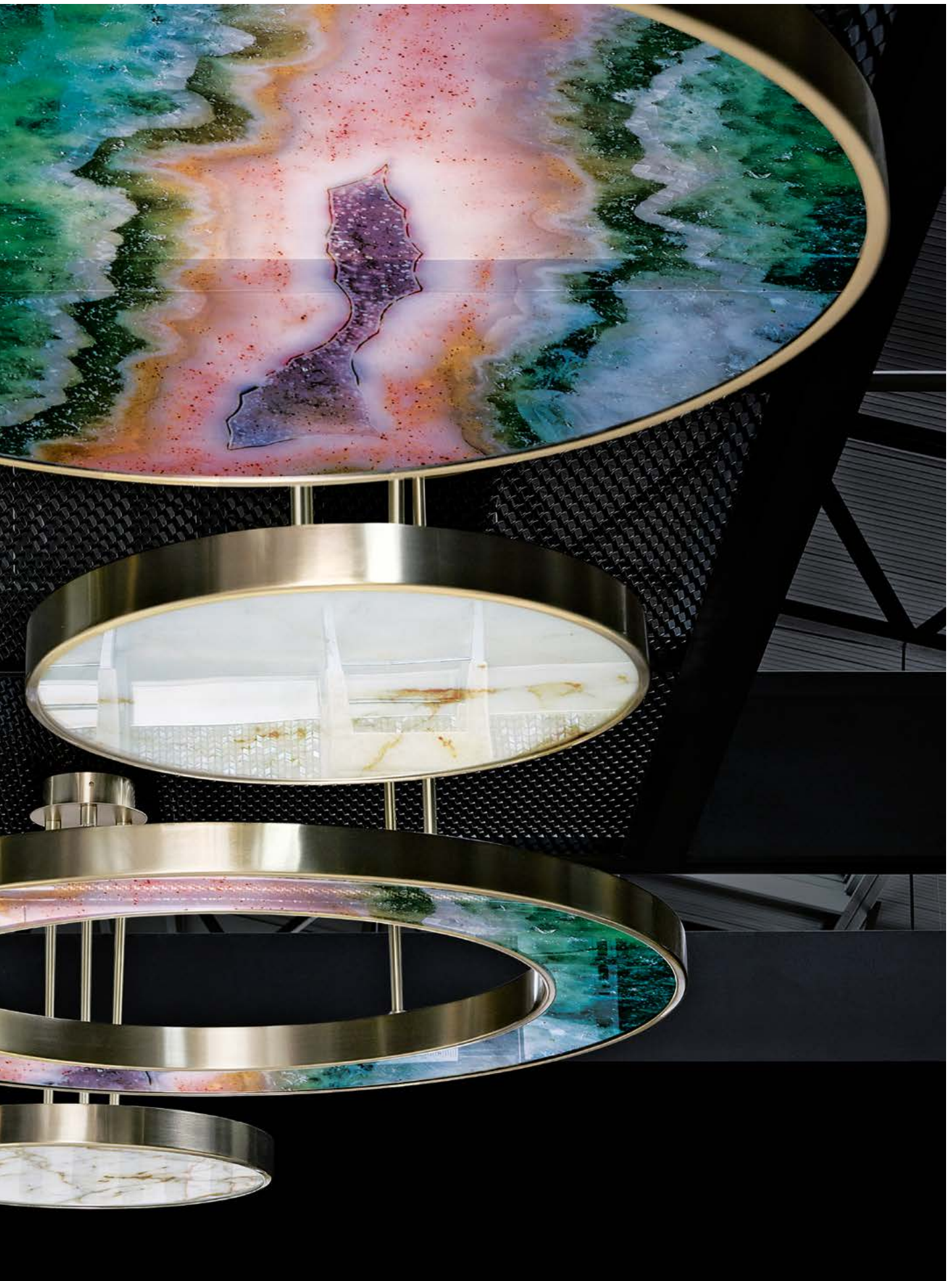











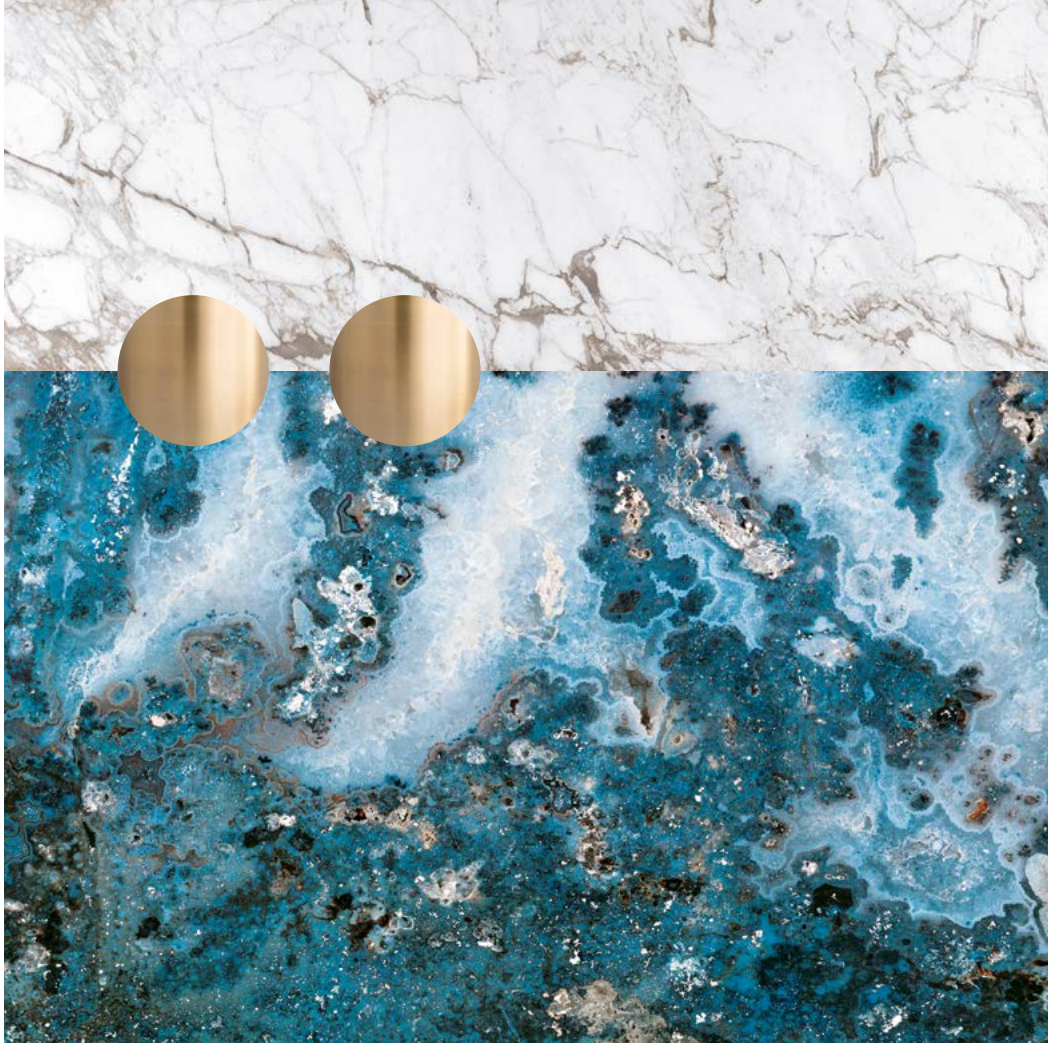

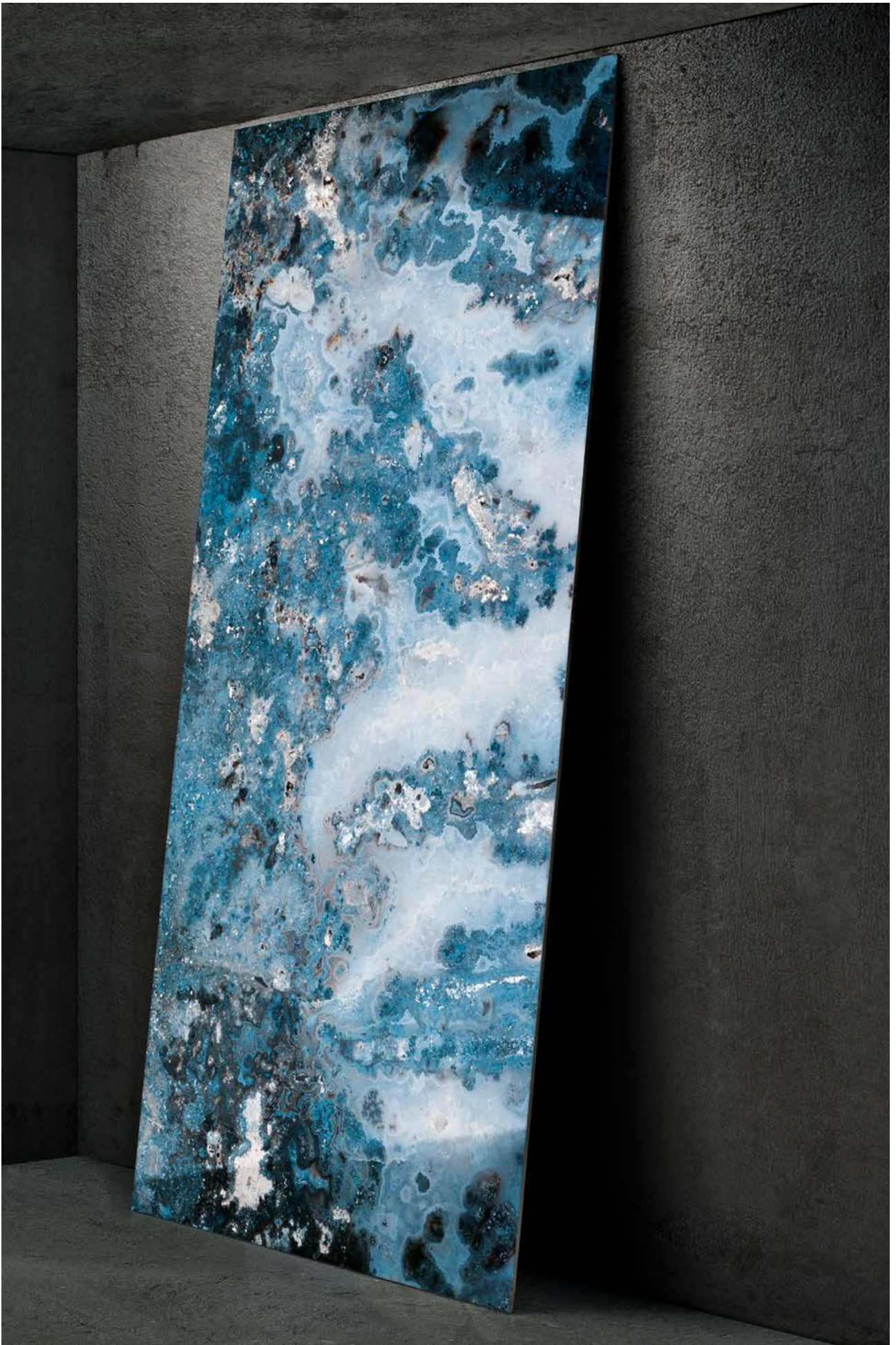













# FROU

# JND

designed by Massimiliano Raggi

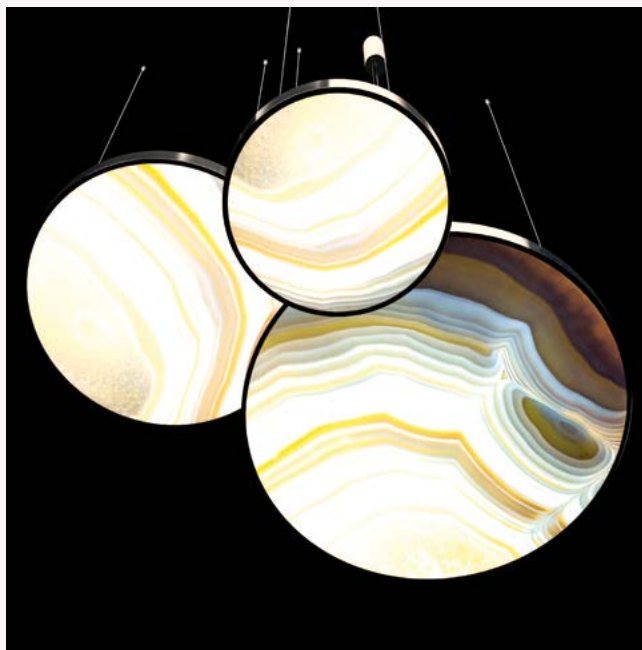

La forma perfetta espressa dal cerchio diventa luce, forza enigmatica, principio di creazione cosmica.

La lampada esalta l'irresistibile bellezza della figura e della materia con cui è realizzata.

*The perfect shape expressed by the circle becomes light, enigmatic force, the origin of cosmic creation. The lamp enhances the irresistible beauty of the figure and the material with which it's made.*

# GEMMA\_ROUND

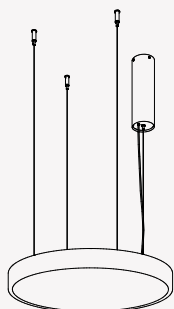

## ROUND 60 **Descrizione / Description**

Lampada a soffitto con struttura metallica, diffusore in Vetrite Electric Marbles o Gem Glass opalescente.

*Metal Ceiling Lamp, opalescent Vetrite Electric Marbles or Gem Glass diffuser.*

### **Informazioni tecniche / Technical information**

58 Watt STRIP LED, 24V,  
WARM WHITE 3000K  
6660lm  
IP 20 - RA80

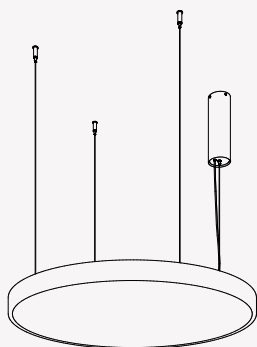

## ROUND 90 **Descrizione / Description**

Lampada a soffitto con struttura metallica, diffusore in Vetrite Electric Marbles o Gem Glass opalescente.

*Metal Ceiling Lamp, opalescent Vetrite Electric Marbles or Gem Glass diffuser.*

### **Informazioni tecniche / Technical information**

127 Watt STRIP LED, 24V,  
WARM WHITE 3000K  
15084lm  
IP 20 - RA80

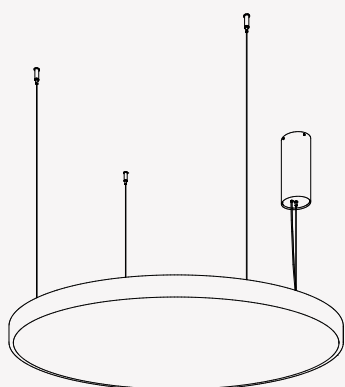

## ROUND 120 **Descrizione / Description**

Lampada a soffitto con struttura metallica, diffusore in Vetrite Electric Marbles o Gem Glass opalescente.

*Metal Ceiling Lamp, opalescent Vetrite Electric Marbles or Gem Glass diffuser.*

### **Informazioni tecniche / Technical information**

195 Watt STRIP LED, 24V,  
WARM WHITE 3000K  
22896lm  
IP 20 - RA80



# GEMMA\_ROUND - RECESSED DRIVER

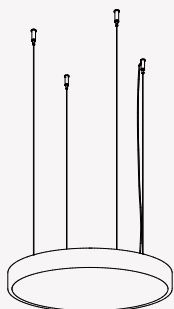

## ROUND 60\_RD Descrizione / Description

Lampada a soffitto con struttura metallica, diffusore in Vetrite Electric Marbles o Gem Glass opalescente.

*Metal Ceiling Lamp, opalescent Vetrite Electric Marbles or Gem Glass diffuser.*

### Informazioni tecniche / Technical information

58 Watt STRIP LED, 24V,  
WARM WHITE 3000K  
6660lm  
IP 20 - RA80

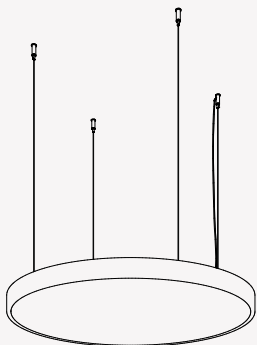

## ROUND 90\_RD Descrizione / Description

Lampada a soffitto con struttura metallica, diffusore in Vetrite Electric Marbles o Gem Glass opalescente.

*Metal Ceiling Lamp, opalescent Vetrite Electric Marbles or Gem Glass diffuser.*

### Informazioni tecniche / Technical information

127 Watt STRIP LED, 24V,  
WARM WHITE 3000K  
15084lm  
IP 20 - RA80

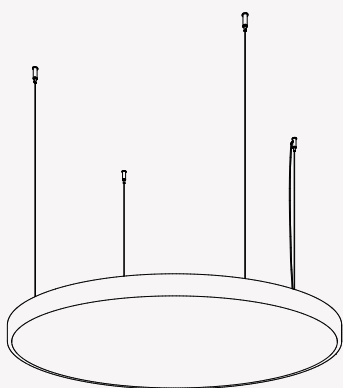

## ROUND 120\_RD Descrizione / Description

Lampada a soffitto con struttura metallica, diffusore in Vetrite Electric Marbles o Gem Glass opalescente.

*Metal Ceiling Lamp, opalescent Vetrite Electric Marbles or Gem Glass diffuser.*

### Informazioni tecniche / Technical information

195 Watt STRIP LED, 24V,  
WARM WHITE 3000K  
22896lm  
IP 20 - RA80





IR



# ING

designed by Massimiliano Raggi

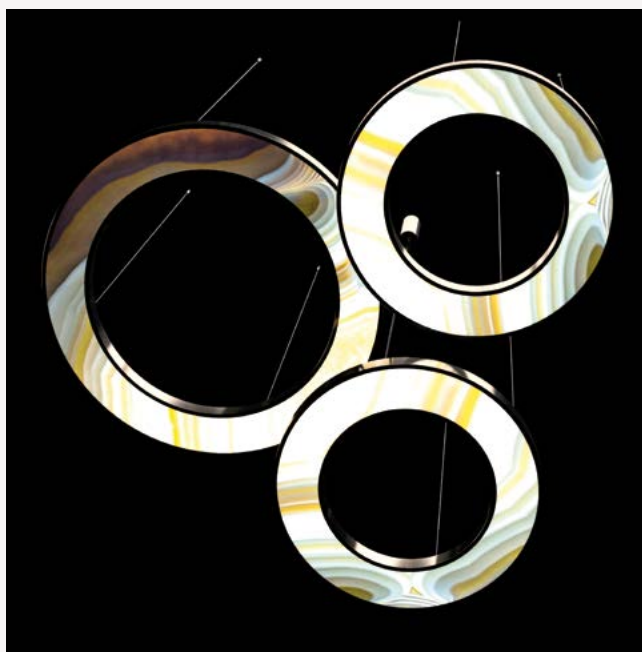

Un anello di luce che esprime dinamismo e centralità. Un oggetto i cui materiali e i giochi di cromie rimandano al poetico mistero di pianeti inesplorati.

*A ring of light that conveys dynamism and centrality. An object whose materials and game of tones refer to the poetic mystery of unexplored planets.*

# GEMMA\_RING

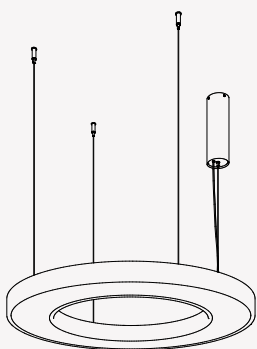

## **RING 90** Descrizione / *Description*

Lampada a soffitto con struttura metallica, diffusore in Vetrite Electric Marbles o Gem Glass opalescente.

*Metal Ceiling Lamp, opalescent Vetrite Electric Marbles or Gem Glass diffuser.*

## **Informazioni tecniche / Technical information**

137 Watt STRIP LED, 24V,  
WARM WHITE 3000K  
13194lm  
IP 20 - RA80

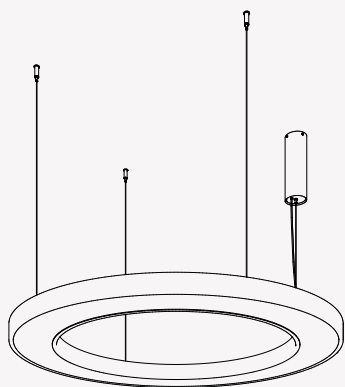

## **RING 120** Descrizione / *Description*

Lampada a soffitto con struttura metallica, diffusore in Vetrite Electric Marbles o Gem Glass opalescente.

*Metal Ceiling Lamp, opalescent Vetrite Electric Marbles or Gem Glass diffuser.*

## **Informazioni tecniche / Technical information**

153 Watt STRIP LED, 24V,  
WARM WHITE 3000K  
18180lm  
IP 20 - RA80



# GEMMA\_RING - RECESSED DRIVER

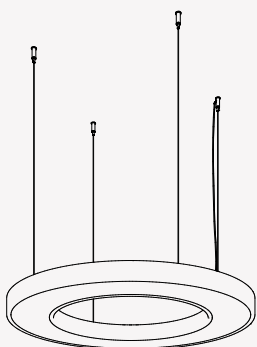

## **RING 90\_RD** Descrizione / Description

Lampada a soffitto con struttura metallica, diffusore in Vetrite Electric Marbles o Gem Glass opalescente.

*Metal Ceiling Lamp, opalescent Vetrite Electric Marbles or Gem Glass diffuser.*

## **Informazioni tecniche / Technical information**

137 Watt STRIP LED, 24V,  
WARM WHITE 3000K  
13194lm  
IP 20 - RA80

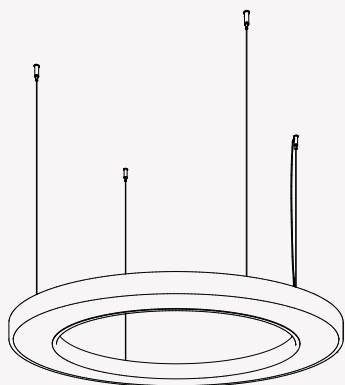

## **RING 120\_RD** Descrizione / Description

Lampada a soffitto con struttura metallica, diffusore in Vetrite Electric Marbles o Gem Glass opalescente.

*Metal Ceiling Lamp, opalescent Vetrite Electric Marbles or Gem Glass diffuser.*

## **Informazioni tecniche / Technical information**

153 Watt STRIP LED, 24V,  
WARM WHITE 3000K  
18180lm  
IP 20 - RA80



# Gemma - DIMENSIONS

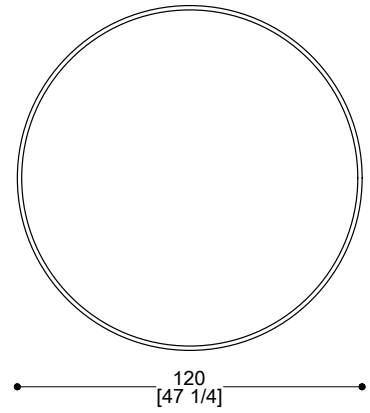
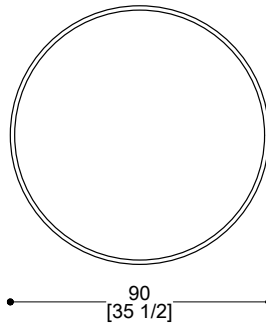
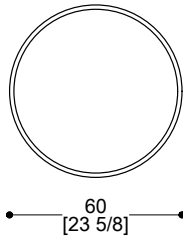

ROUND

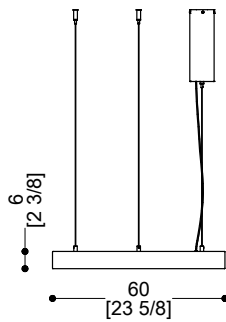

**ROUND 60**

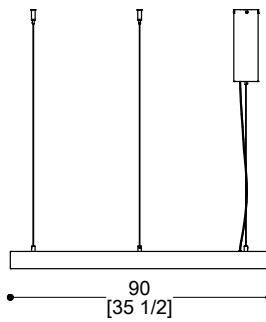

**ROUND 90**

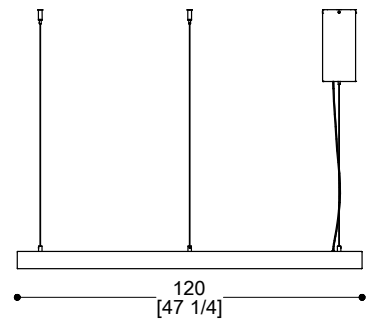

**ROUND 120**

ROUND  
RECESSED DRIVER

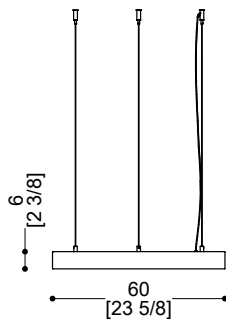

**ROUND 60\_RD**

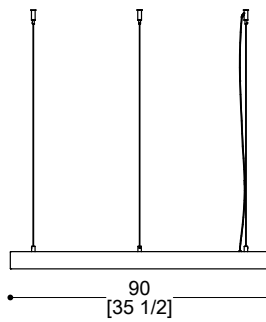

**ROUND 90\_RD**

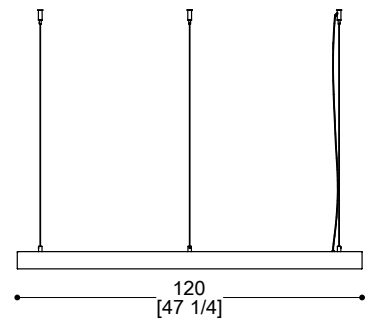

**ROUND 120\_RD**

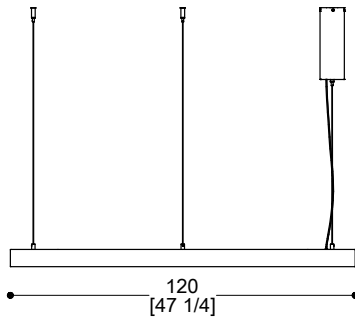
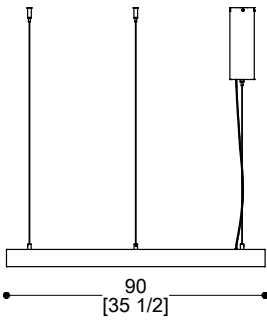
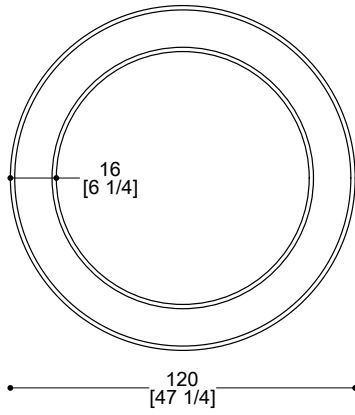
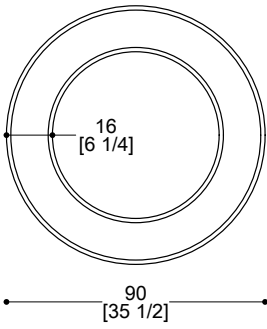

RING

RING 90

RING 120

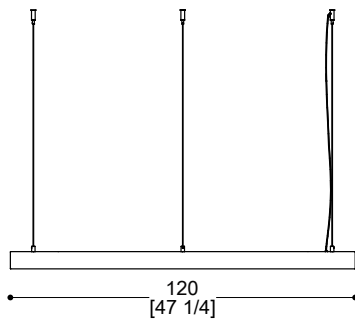
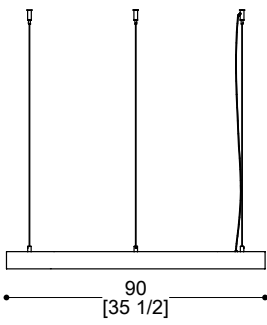

RING  
RECESSED DRIVER

RING 90\_RD

RING 120\_RD

LIGHT OFF



LIGHT ON





LIGHT ON







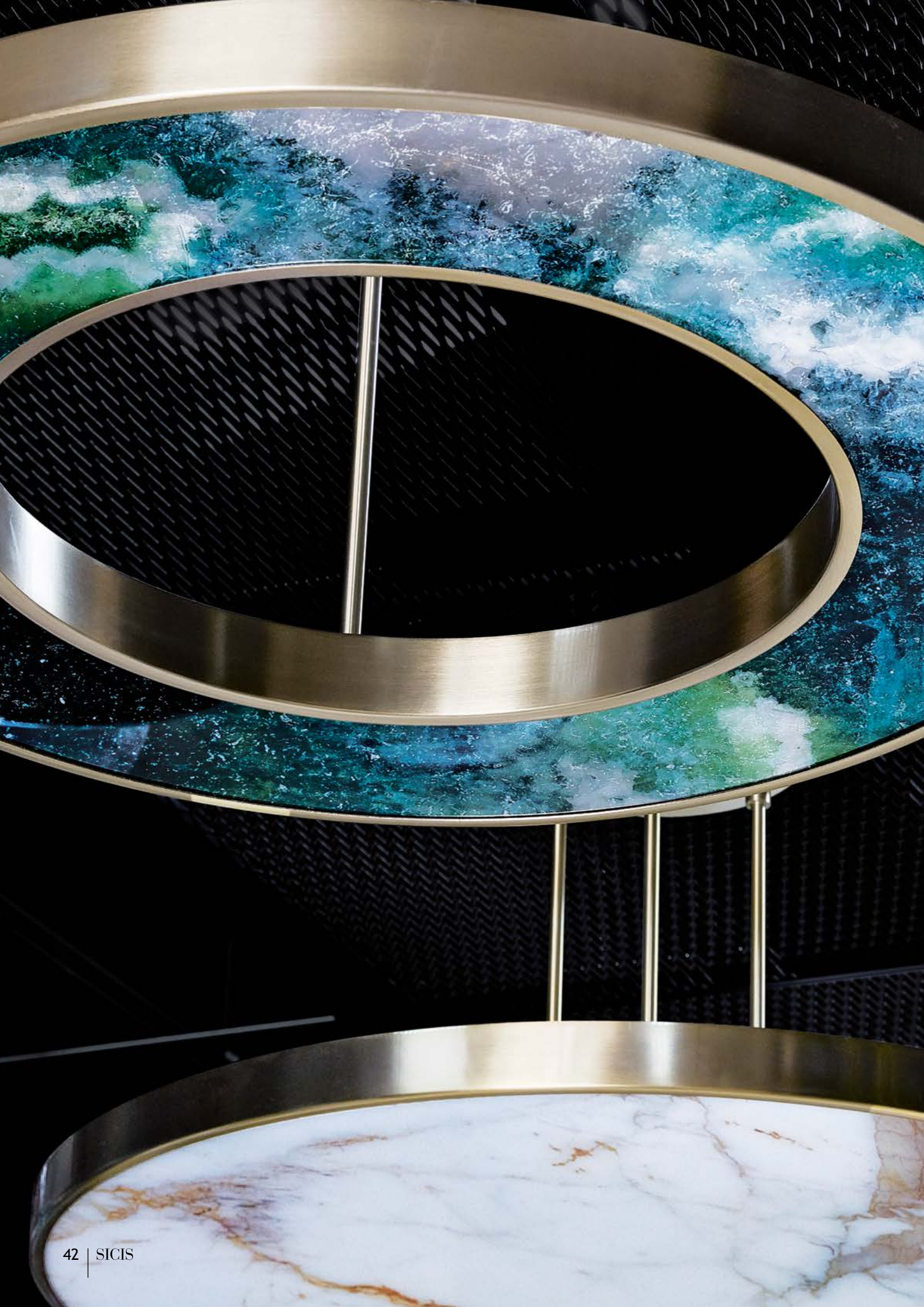

# Gemma - structure finish



Metallo champagne opaco  
*Champagne matt metal*



Metallo argento opaco  
*Silver matt metal*



Metallo nickel opaco  
*Nickel matt metal*







# Gemma - diffuser finish

## GEM GLASS COLLECTION

Agata Blue



Agata Lilla



Aurora



Bloomer



Boulder



Canyon



Cave



Fable



Frost



Galaxy



Grain



Ignite

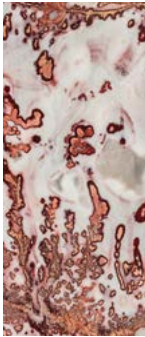

Lagoon



Lake



Punctum

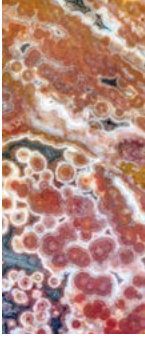

Reef



River

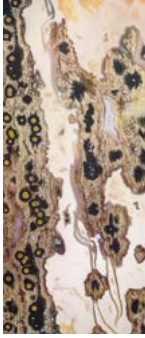

Rock



Sepia

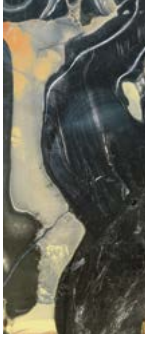

Solferino



Sunburst





Chroma



Cliff



Clouds

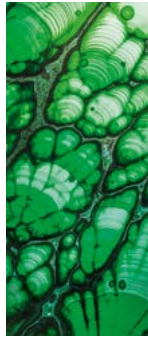

Corundum



Crater



Crimson



Crystallised

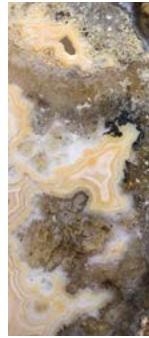

Landscape



Lignin



Magma

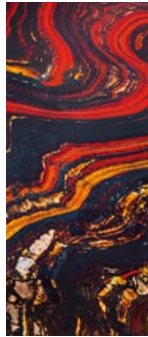

Mahogany



Neve



Pangea Red A



Pangea Red B



Terrain



Unakite

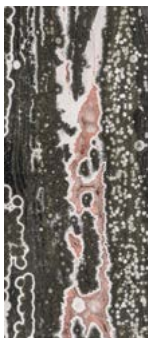

Vulcano



Waves



## ELECTRIC MARBLE COLLECTION

Natural



Turchese

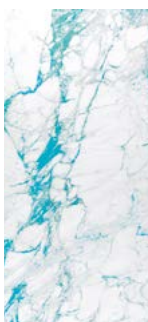

Gold



Fuxia

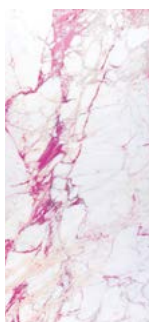

# Gemma - diffuser finish

## SIGHT COLLECTION

Accra 01



Accra 02



Dubai 01



Hanoi 01



Hanoi 02



Hanoi 02 B&W



Los Angeles 01



Los Angeles 02



Milano 01



Milano 02



Roma 01



Roma 02



Shanghai 01



Shanghai 02



Venezia 01



Venezia 02



## AVVISO LEGALE

Ricevendo il presente catalogo SICIS, prendi atto ed accetti i seguenti termini e condizioni:

Il presente catalogo è e rimane di proprietà di SICIS S.r.l. ("SICIS").

SICIS si riserva il diritto, in qualsiasi momento, di richiederne la restituzione. Il catalogo è fornito a TITOLO GRATUITO e NON ne è AUTORIZZATA LA RIVENDITA. Se hai dovuto pagare per questo catalogo, ti preghiamo di segnalarcelo scrivendoci all'indirizzo riportato di seguito.

Le leggi in materia di diritto d'autore (Copyright) proteggono il contenuto del presente catalogo, inclusi, senza alcuna limitazione, le fotografie, immagini, testi, layout ed i disegni in esso contenuti.

La riproduzione o la copia di qualsiasi parte del presente catalogo, inclusi, senza alcuna limitazione, le fotografie, immagini, testi, layout ed i disegni in esso contenuti, È VIETATA, e SICIS si riserva il diritto di intraprendere azione legale nei confronti di chiunque (incluso te) violi il presente divieto.

L'aver ricevuto una copia del presente catalogo, non dà diritto in alcun modo ad alcuna licenza da parte di SICIS, né implicita né tantomeno espressa, di riprodurre o copiare, in qualsiasi modo o forma, alcuna parte di esso.

Il marchio SICIS® è un marchio registrato e di proprietà della SICIS S.r.l., ed è protetto dalle leggi nazionali ed internazionali in materia.

SICIS espressamente si riserva tutti i diritti e rimedi.

## LEGAL NOTICE

By retaining this SICIS catalogue, you acknowledge and agree to the following:

This catalogue is and remains the property of SICIS S.r.l. ("SICIS").

SICIS reserves the right, at any time, to request the return of this catalogue. The catalogue is provided to you FREE OF CHARGE and is NOT FOR RESALE. If you paid for this catalogue, please write to SICIS at the address provided below.

Copyright laws protect the content of this catalogue, including, without limitation, the photographs, images, text, layout and designs contained therein.

The reproduction or copying of any part of this catalogue, including, without limitation, the photographs, images, text, layout and designs contained therein, IS PROHIBITED, and legal action may be commenced against anyone, including, but not limited to, yourself, who violates this prohibition.

By giving you a copy of this catalogue, SICIS is not thereby giving you any license, either implied or express, to reproduce or copy it or any parts of it, in any way.

The trademark SICIS® is a registered trademark and the property of SICIS S.r.l., and is protected under domestic and international laws.

SICIS reserves all its rights and remedies.

[www.sicis.com](http://www.sicis.com) · [info@sicis.com](mailto:info@sicis.com)

SICIS · Sede Legale · Via Borgonuovo, 29 · 20121 Milano (Italy)

Sicis s.r.l. Ravenna (Italy) - April 2022

© 2019-2020-2021-2022 Sicis S.r.l.

SICIS® is trademark of Sicis S.r.l.

*SICIS® è un marchio di Sicis S.r.l.*

### SICIS ITALY

#### Showroom Milano

20121 · Via Fatebenefratelli, 8

Ph. +39 02 87 60 99 · Fax +39 02 72 09 68 53

Showroom & Factory Ravenna (Italy)

48123 · Via Canala, 85

Ph. +39 0544 469 711 · Fax +39 0544 46 98 11

### SICIS FRANCE

#### Showroom Paris

75008 · 41, Rue François 1er

Ph. +33 (0)1 4952 8989 · Fax +33 (0)1 4952 8990

### SICIS SPAIN

#### Showroom Madrid

28006 · 33, calle José Ortega y Gasset

Ph. +34 910572844

### SICIS UNITED KINGDOM

#### Showroom & Offices London

15A Dover St, Mayfair, W1S 4LR

Ph. +44 207 491 9849

### SICIS H.K. LIMITED

Room D, 24F, Tai Yau Building

181 Johnston Road, Wanchai, Hong Kong

Ph. +(852) 2832 2830 · Fax +(852) 2833 9009

### SICIS NORTH AMERICA

#### Corporate Headquarters New York

10454 · 150 Bruckner Blvd Bronx

Ph. +1 212 965 4100 · Fax +1 646 390 4587

