

collection 2022



I CATINI

hand made — in Italy.

cielo

I CATINI

**“CERCAVAMO OGGETTI RICCHI DI SIGNIFICATO...
APPLICANDO IL FILTRO DELLA CONTEMPORANEITÀ”
“WE WERE SEARCHING FOR OBJECTS FULL OF MEANING...
APPLYING A CONTEMPORARY FILTER”**

design Andrea Parisio and Giuseppe Pezzano

cielo

I CATINI

Il progetto reinterpreta in chiave moderna uno degli oggetti simbolo dell'arredobagno dei primi Novecento. Protagonista indiscussa della collezione è la ceramica che, grazie alla straordinaria capacità di lavorazione dell'Azienda, diventa un oggetto innovativo e originale in grado di raccontare, attraverso un linguaggio contemporaneo, la bellezza della memoria.

L'iconica collezione I Catini di Ceramica Cielo presentata nel 2016 nelle tre diverse varianti Tondo, Ovale e Doppio o Rettangolare, si arricchisce di nuove esclusive soluzioni che definiscono uno spazio sempre più distintivo: il mobile freestanding con lavabo integrato in ceramica Tiberio, tre bacinelle, un sistema doccia, una coppia di sanitari sospesi e due vasche.

Continua, dunque, il viaggio dell'Azienda nel proporre un'idea sempre nuova e attuale in cui i designer Andrea Parisio e Giuseppe Pezzano reinterpretano in chiave contemporanea le forme archetipe degli elementi da bagno. Tratto distintivo, in continuità formale con la collezione, è un design semplice ma di grande forza plastica che ne permette il facile inserimento in qualsiasi contesto dell'abitare.

La nobiltà della ceramica, unita all'incontro con altri materiali ed alle suggestioni delle Terre e delle Acque di Cielo, rende la collezione I Catini fortemente personalizzabile dando vita ad una grande versatilità compositiva ed infinite composizioni.

Completano la collezione eleganti specchi tondi e ovali attrezzati con ripiani interni e con scocca in legno laccato nero, cemento, bronzo spazzolato o nelle Acque di Cielo.

The project reinterprets in a modern way one of the most iconic objects of early 20th century bathroom design. The undisputed protagonist of the collection is the ceramic which, thanks to the Company's extraordinary manufacturing capacity, becomes an innovative and original object capable of narrating through a contemporary language, the beauty of memory.

Ceramica Cielo's iconic I Catini collection, presented in 2016 in the three different variants Round, Oval and Double or Rectangular, is enriched with new exclusive solutions that define an increasingly distinctive space: the freestanding cabinet with the integrated Tiberio ceramic washbasin, three washbasins, a shower system, a pair of suspended sanitary ware and two bathtubs.

Thus, the company's journey continues with a proposing an ever new and up-to-date idea in which the designers Andrea Parisio and Giuseppe Pezzano reinterpret the archetypal forms of the bathroom elements in a contemporary way. A distinctive trait, in formal continuity with the collection, is the simple design with great sculptural strength that allows it to fit easily into any living context.

The nobility of ceramics, united with the combination of other materials and the allure of Terre and Acque di Cielo, make the I Catini collection highly customisable, giving life to great compositional versatility and infinite compositions.

The collection is completed by elegant round and oval mirrors that can be fitted with internal shelves and with a lacquered wooden frame in black, Cemento, brushed bronze or Acque di Cielo.

**INTRODUZIONE
INTRODUCTION**

06

**ABACO PRODOTTI & FINITURE
ABACO PRODUCTS & FINISHES**

48

TIBERIO

08

AUGUSTO

12

OFELIA

OTTAVIA

18

SANITARI

42

L'espressione Made in Italy, con cui Cielo vuole accompagnare il proprio marchio, racchiude in sé quei valori che contraddistinguono l'eccellenza del "fare" italiano considerato come un vero e proprio modello di riferimento nel mondo; la qualità del design, la selezione dei materiali migliori, la cura del dettaglio, la conoscenza dell'artigianalità e la ricerca costante dell'armonia tra forma e funzione.

L'ambizione di Cielo è di diventare un laboratorio del vero Made in Italy che possa promuovere la nostra identità culturale ponendo l'uomo al centro del progetto.

IL LABORATORIO DELLA CERAMICA THE CERAMIC WORKSHOP

The expression 'Made in Italy', with which Cielo wants to accompany its brand, encapsulates those values that distinguish the excellence of Italian 'making' considered as a true reference model in the world; the quality of design, the selection of the best materials, the attention to detail,

the knowledge of craftsmanship and the constant search for harmony between form and function.

Cielo's ambition is to become a workshop of true Made in Italy that can promote our cultural identity by placing people at the centre of the project.

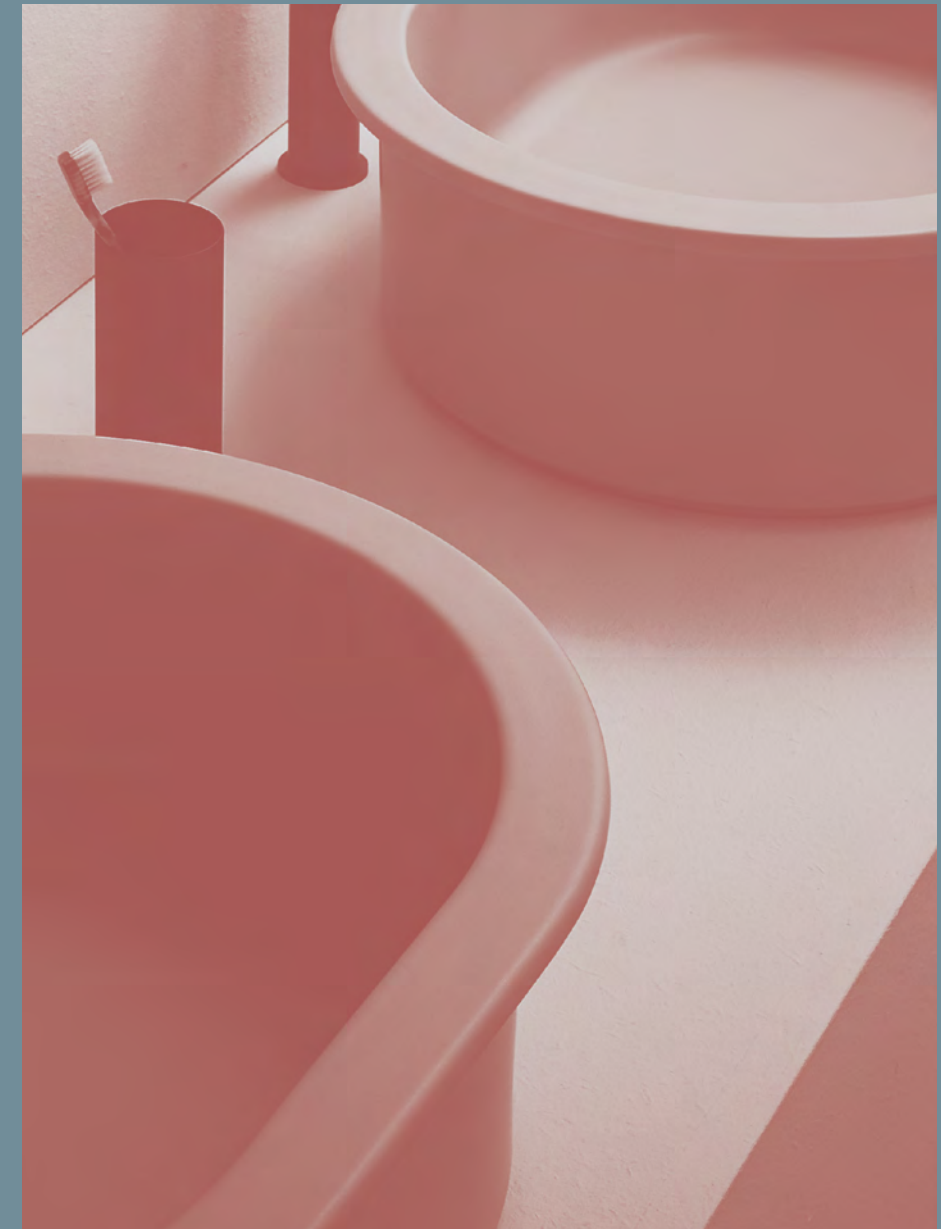

design Andrea Parisio and Giuseppe Pezzano



TIBERIO UN ELEGANTE DIALOGO TRA CERAMICA E LEGNO

AN ELEGANT DIALOGUE BETWEEN CERAMIC AND WOOD

Tiberio: un lavabo ovale abbracciato da una sinuosa e sofisticata curva in legno laccato o in essenza, che lo sostiene e funge da pratico elemento contenitore. Un dialogo tra ceramica e legno da cui nascono diverse interpretazioni di un unico modello.

Tiberio: an oval washbasin embraced by a sinuous and sophisticated curve in lacquered wood or wood veneer, which supports it and acts as a practical storage element. A dialogue between ceramic and wood from which different interpretations of a single model are born.



Scenografico e dai volumi importanti, è il piatto doccia Augusto in ceramica. Forma semi circolare, bordo alto 20 cm, estrema flessibilità di posizionamento lungo le pareti. L'elegante struttura in metallo, regolabile in altezza, atta a sorreggere la tenda, consente di essere utilizzata sia in ambienti domestici di dimensioni tradizionali sia in contesti da altezze più importanti.

The Augusto ceramic shower tray is spectacular with generous dimensions. Semi-circular shape, 20 cm high edge, extreme flexibility of positioning along the walls. The elegant metal structure, adjustable in height, used to hold the tent allows it to be used both in traditionally sized domestic environments and in settings with greater heights.

P. 10-11 Augusto: piatto doccia in ceramica finitura Avena. Asta doccia finitura Nero Matt. Tiberio: lavabi in ceramica finitura Canapa, mobili laccati Avena. Portasciugamani ovale 30: finitura Anemone. Specchio tondo con cinta in cuoio.

P. 10-11 Augusto: ceramic shower tray in Avena finish. Shower rod Matt Black finish. Tiberio: washbasins in ceramic Canapa finish, cabinets in Avena lacquered finish. Oval towel rail 30: Avena finish. Round mirror with leather trim.

P. 13 Augusto: piatto doccia in ceramica finitura Avena. Mensola tonda: finitura Anemone, con piano in vetro.

P. 13 Augusto: ceramic shower tray in Avena finish. Round shelf: Anemone finish, with glass top.





Tiberio: lavabo in ceramica finitura Canapa, mobile laccato finitura Avena. Portasciugamani ovale 30: finitura Anemone.

Tiberio: ceramic washbasin in Canapa finish, cabinet in lacquered Avena finish. Oval towel rail 30: Anemone finish.



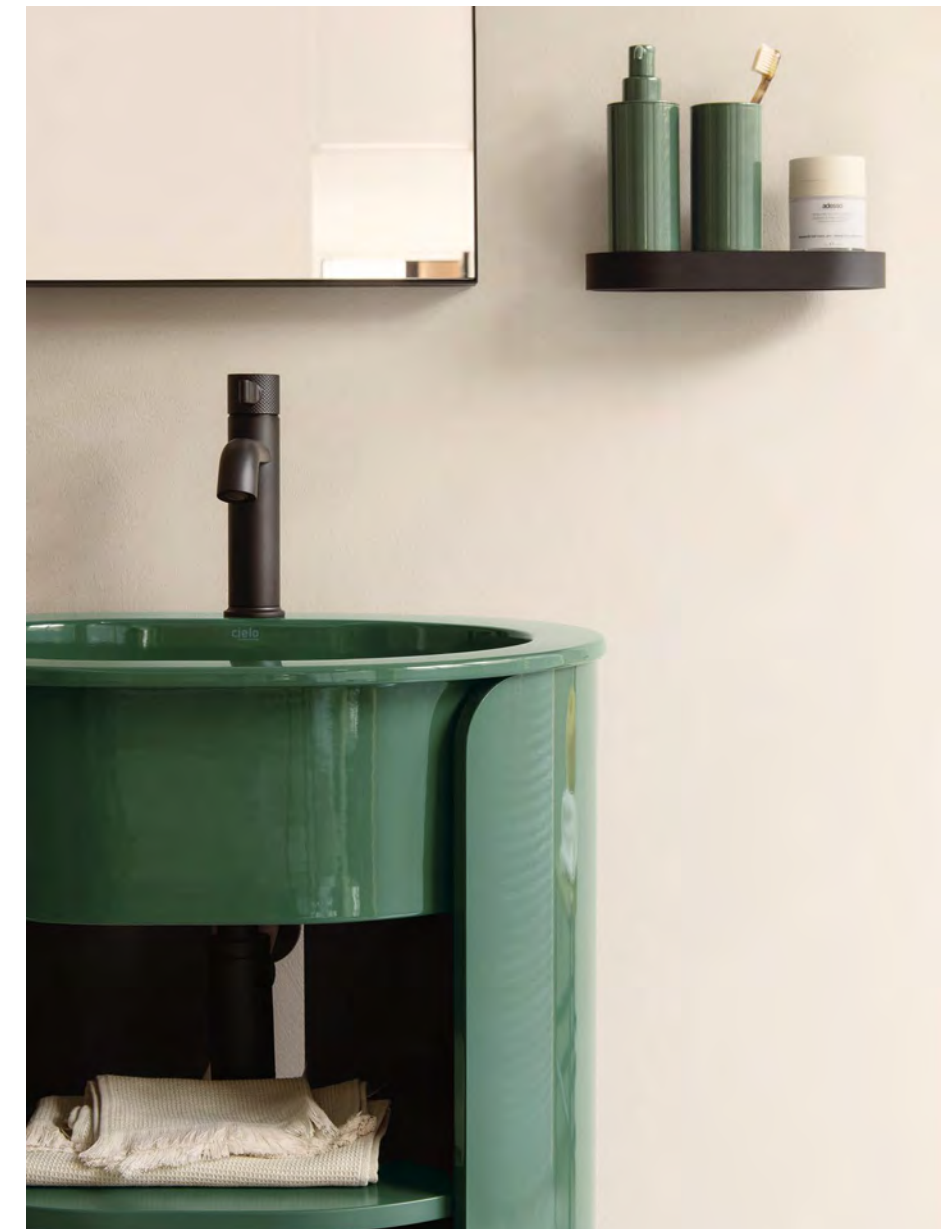

Tiberio: lavabo in ceramica finitura Alga, mobile laccato Alga. Specchio Argo a parete: finitura Nero Matt. Portasciugamani ovale 45: finitura Nero Matt. Mensola ovale: finitura Nero Matt, con piano in vetro. Bicchieri e dispenser in metallo: finitura Alga.

Tiberio: ceramic washbasin in Alga finish, cabinet in lacquered Alga finish. Argo wall mirror: Matt Black finish. Oval towel rail 45: Matt Black finish. Oval shelf: Matt Black finish, with glass top. Glass and metal dispenser: Alga finish.

design Andrea Parisio and Giuseppe Pezzano

OFELIA E OTTAVIA UN RACCONTO CONTEMPORANEO DELLE BAIGNOIRE

A CONTEMPORARY TALE OF "BAIGNOIRE" BATHTUBS

Due vasche da bagno in Livingtec su struttura in metallo, ricordano le classiche baignoire reinterpretate in chiave contemporanea sia nelle forme che nel materiale. Ottavia si contraddistingue per le linee simmetriche ed è pensata per accogliere anche due persone; Ofelia presenta un comodo schienale e un bordo che funge da pratico piano d'appoggio.

Two bathtubs in LivingTec positioned on metal structures, reminiscent of the classic "baignoire" reinterpreted in a contemporary way in both shape and material. Ottavia is characterised by symmetrical lines and is designed to accommodate two people; Ofelia features a comfortable backrest and a rim that serves as a practical shelf.

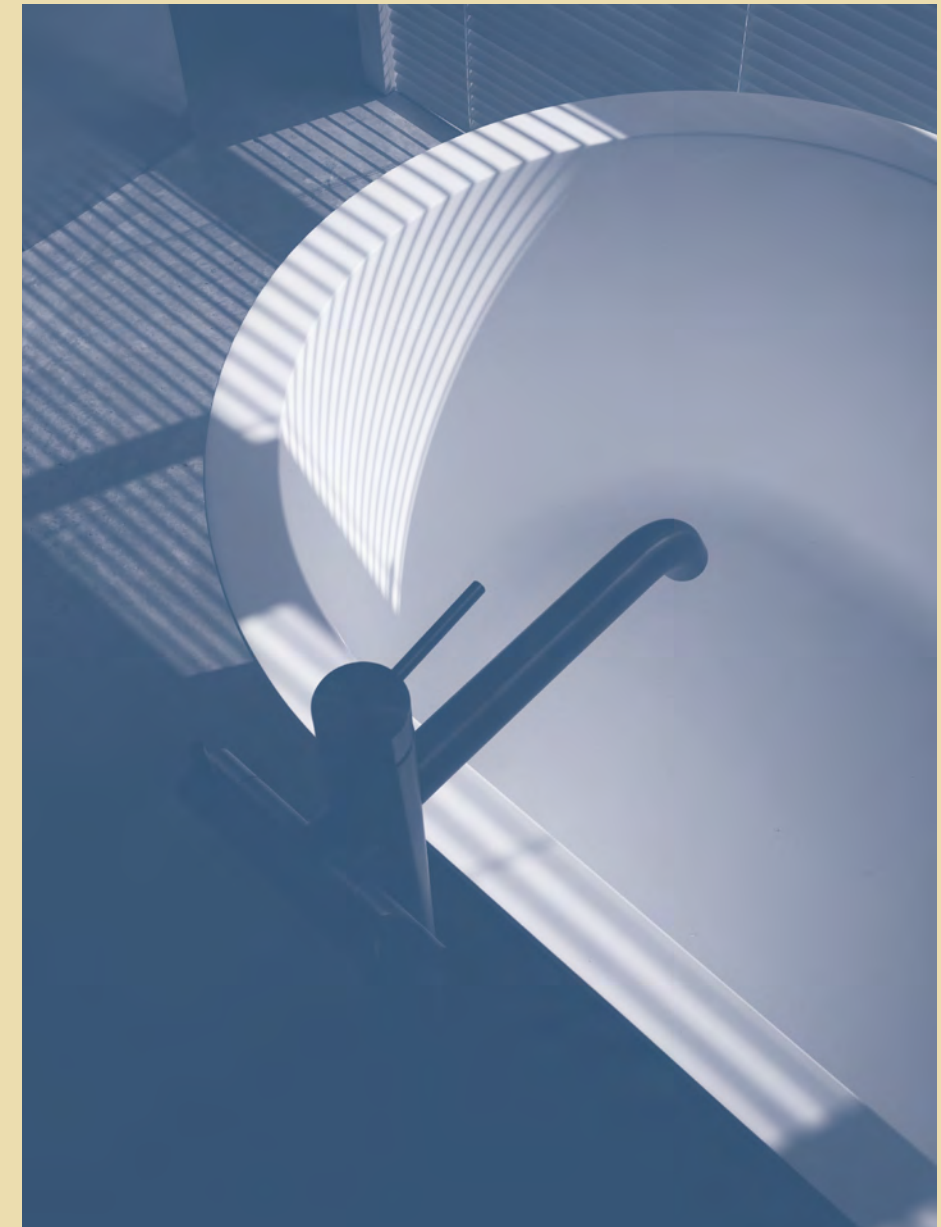





P. 20-21: Bacinelle ovali Catino 55: finitura Lino. Specchi Marcel contenitori rettangolari a doppia anta, in frassino naturale e frontalino in Paglia di Vienna. Bicchieri in metallo: finitura Nero Matt. Vasca Ofelia in LivingTec: finitura Bianco Matt, struttura finitura Nero Matt.

P. 20-21: Catino 55 oval basins: Lino finish. Marcel rectangular cabinet mirrors with double door, in natural ash with Vienna Straw front. Metal glass: Matt Black finish. Ofelia bathtub in LivingTec: Matt White finish, structure in Matt Black finish.





Vasca Ofelia in LivingTec: finitura Bianco Matt, struttura in metallo finitura Nero Matt.

Ofelia bathtub in LivingTec: White Matt finish, metal structure Matt Black finish.

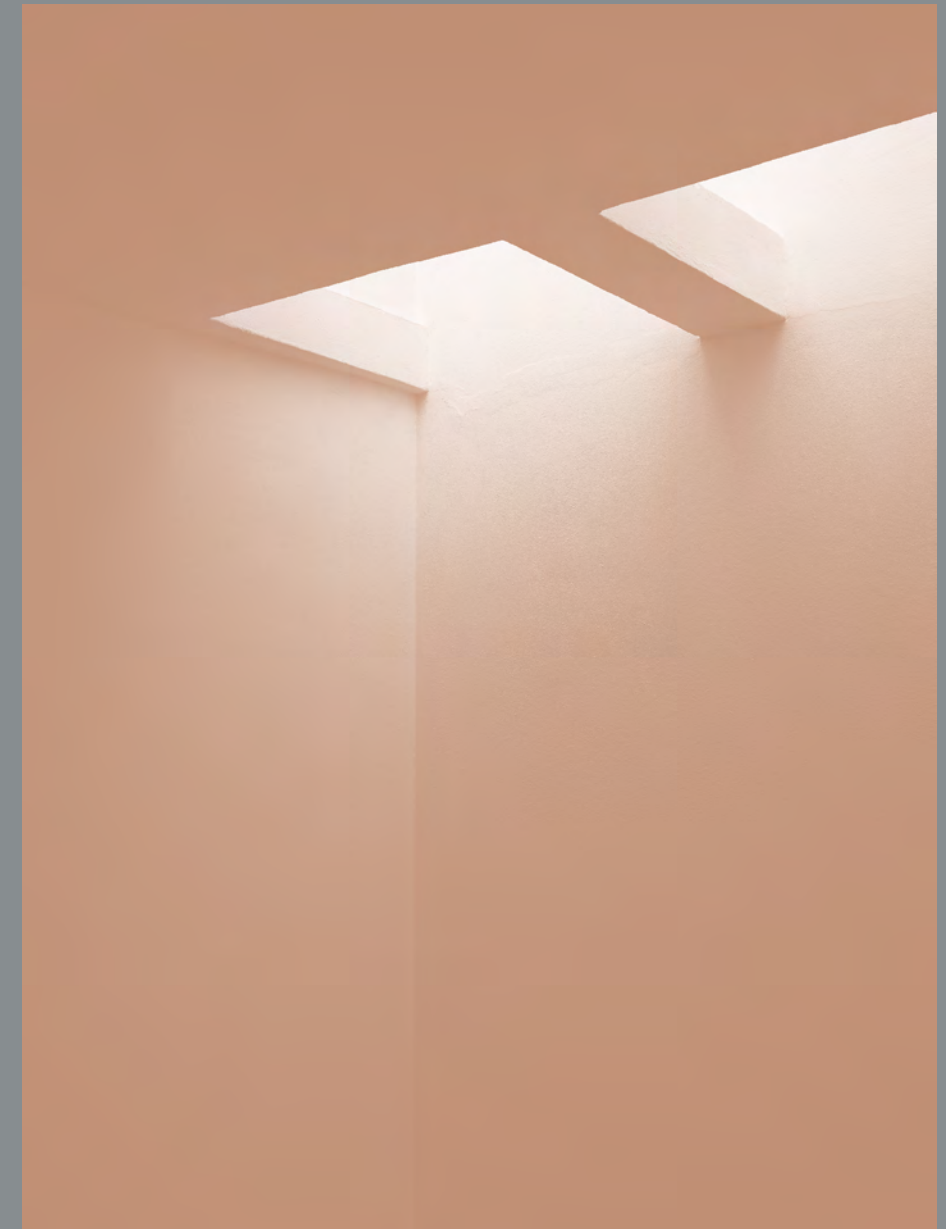

Le due eleganti vasche in LivingTec, sono proposte nelle finiture Bianco Matt, Arenaria e Brina, e sorrette dalla struttura in metallo disponibile nelle finiture Nero Matt, Cemento e Bronzo Spazzolato.

The two elegant LivingTec bathtubs are offered in Matt White, Arenaria and Brina finishes and are supported by a metal frame available in Matt Black, Cemento and Brushed Bronze finishes.

Catino Tondo: lavabi in ceramica finitura Cemento, strutture finitura Cemento, piani in marmo Bianco Carrara.
Specchi Oval: finitura Cemento. Mensola: struttura Nero Matt, piano in LivingTec finitura Bianco Matt.
Vasca Ottavia in LivingTec: finitura Bianco Matt, struttura in metallo Nero Matt.

Catino Tondo: ceramic washbasins in Cemento finish, structures in Cemento finish, countertops in Carrara white marble. Oval mirrors: Cemento finish. Shelf: structure Matt Black, LivingTec countertop in Matt White finish.
Ottavia bathtub in LivingTec: Matt White finish, Matt Black metal structure.







design Andrea Parisio and Giuseppe Pezzano

I CATINI TONDO, OVALE E RETTANGOLARE I GRANDI CLASSICI

ROUND, OVAL AND RECTANGULAR THE GREAT CLASSICS

Icona per eccellenza. Il Catino è un prodotto dal design unico, con un'identità inconfondibile. Grazie ad innumerevoli combinazioni di finiture dà la possibilità di esprimere la propria personalità.

Icon par excellence. The Catino is a uniquely designed product with an unmistakable identity. Thanks to countless combinations of finishes, it gives you the opportunity to express your personality.





Catino Ovale: lavabo e piano in ceramica finitura Fango, struttura finitura Nero Matt. Specchio Oval Box: finitura Nero Matt. Gancio: finitura Nero Matt. Piatto doccia Infinito H3: finitura Talco.

Catino Ovale: ceramic washbasin and countertop in Fango finish, structure in Matt Black finish. Oval Box mirror: Matt Black finish. Hook: Matt Black finish. Infinito H3 shower tray: Talco finish.





P. 38-39 Catino Ovale: lavabo e piano in ceramica finitura Fango, struttura finitura Nero Matt. Specchio Oval Box: finitura Nero Matt. Gancio: finitura Nero Matt. Wc e bidet sospesi I Catini: finitura Alga. Mensola Ovale: finitura Nero Matt, piano in vetro. Piatto doccia Infinito H3: finitura Talco.

P. 38-39 Catino Ovale: ceramic washbasin and countertop in Fango finish, structure in Matt Black finish. Oval Box Mirror: Matt Black finish. Hook: Matt Black finish. I Catini suspended toilet and bidet: Alga finish. Shelf: Matt Black finish, glass top. Infinito H3 shower tray: Talco finish.





Design essenziale e confortevole, in grado di esaltare la purezza formale, caratterizza i nuovi sanitari sospesi I Catini. Sono disponibili nella versione senza brida con la rivoluzionaria tecnologia Rimless 2.0.1 – brevettata dall'Azienda – in grado di coniugare estetica, funzionalità, risparmio idrico e massima efficienza igienica.

Essential and comfortable design, enhancing formal purity, characterises the new I Catini suspended sanitaryware. They are available in the rimless version with the revolutionary Rimless 2.0.1 technology – patented by the company – that combines aesthetics, functionality, water saving and maximum hygienic efficiency.

Wc e bidet sospesi I Catini: finitura Anemone. Portasciugamani ovale 30: finitura Anemone.

I Catini suspended toilet and bidet: Anemone finish. Oval towel rail 30: Anemone finish.



Catino Doppio: lavabo in ceramica finitura Lino, struttura finitura Nero Matt, cassetto in essenza finitura Rovere Sbiancato. Bicchieri in metallo, finitura Anemone. Specchio Round Box 90: finitura Anemone. Wc e bidet sospesi I Catini: finitura Anemone. Mensola Tonda: finitura Anemone, piano in vetro.

Catino Doppio: washbasin in Lino finish, structure in Matt Black finish, drawer in Rovere Sbiancato finish. Metal glass, Anemone finish. Round Box 90 mirror: Anemone finish. I Catini suspended toilet and bidet: Anemone finish. Tonda Shelf: Anemone finish, glass top.





Catino Rettangolare: lavabo in ceramica finitura Ninfea, struttura finitura Nero Matt, piano in pietra Azul Noche.
Specchio Simple Tall Box: finitura Nero Matt. Portasciugamani Ovale 30: finitura Nero Matt.

Catino Rettangolare: ceramic washbasin in Ninfea finish, structure in Matt Black finish, countertop in Azul Noche stone. Simple Tall Box Mirror: Matt Black finish. Oval Towel Rail 30: Black Matt finish.



ABACO PRODOTTI & FINITURE
ABACO PRODUCTS & FINISHES

LAVABO WASHBASIN

CERAMICA / CERAMIC
LE ACQUE DI CIELO



CERAMICA / CERAMIC
LE TERRE DI CIELO



PIANO SHELF

CERAMICA / CERAMIC
LE ACQUE DI CIELO



CERAMICA / CERAMIC
LE TERRE DI CIELO



PIETRA / STONE

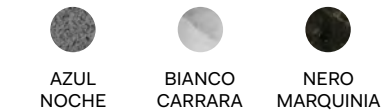

CASSETTO DRAWER

ESSENZA / WOOD



LACCATURE / LACQUERING
LE TERRE DI CIELO



STRUTTURA FRAMEWORK

METALLO / METAL



METALLO / METAL
LE ACQUE DI CIELO



I CATINI

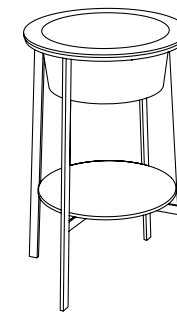

CATINO TONDO
cm Ø50 x 83 h

CATINO OVALE
con piano / with shelf
con cassetto / with drawer
cm 70 x 50 x 83 h

CATINO OVALE MONOFORO
con piano / with shelf
con cassetto / with drawer
cm 70 x 50 x 83 h

CATINO DOPPIO
con piano / with shelf
con cassetto / with drawer
cm 110 x 58,5 x 83 h

CATINO RETTANGOLARE
con piano / with shelf
con cassetto / with drawer
cm 110 x 58,5 x 83 h

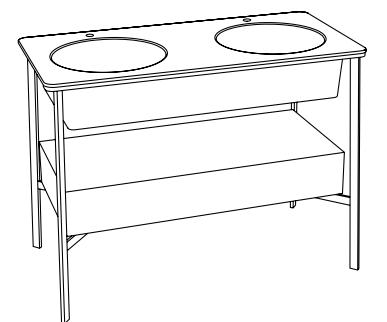
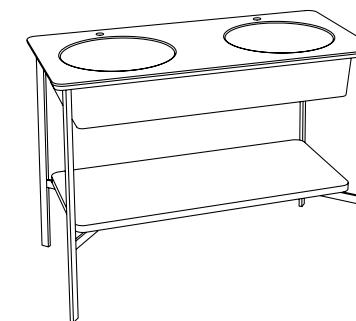
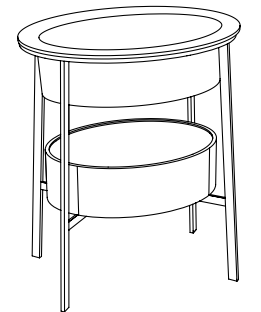
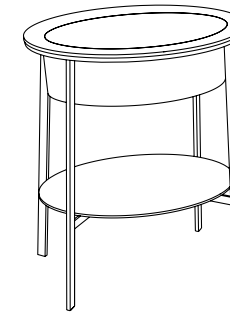

Nella versione del Catino Doppio e Rettangolare, i piani sono disponibili nelle seguenti finiture: essenza Rovere Naturale, Rovere Sbiancato, Rovere Nero, Rovere Grigio, Eucalipto; laccati nelle Terre di Cielo: Talco, Pomice, Brina, Arenaria, Avena, Cemento, Basalto, Muschio; marmo Bianco Carrara, Nero Marquina, Azul Noche.

In the Double and Rectangular Basin versions, the countertops are available in the following finishes: Rovere Naturale, Rovere Sbiancato, Rovere Nero, Rovere Grigio, Eucalipto; Terre di Cielo lacquers: Talco, Pomice, Brina, Arenaria, Avena, Cemento, Basalto, Muschio; White Carrara, Black Marquina, Azul Noche marble.

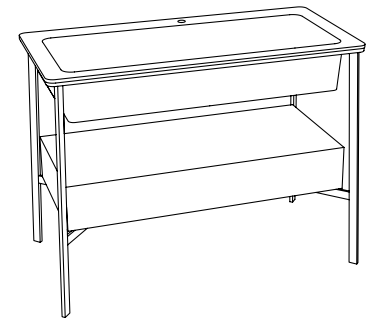
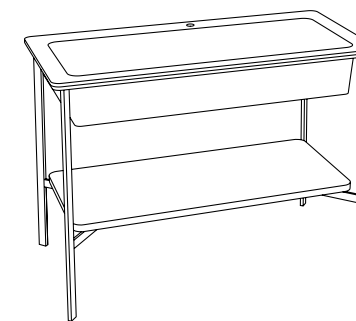

LAVABO WASHBASIN

CERAMICA / CERAMIC
LE ACQUE DI CIELO



CERAMICA / CERAMIC



CERAMICA / CERAMIC
LE TERRE DI CIELO



MOBILE CABINET

ESSENZA / WOOD



LACCATURE / LACQUERING
LE ACQUE DI CIELO



LACCATURE / LACQUERING
LE TERRE DI CIELO



TIBERIO

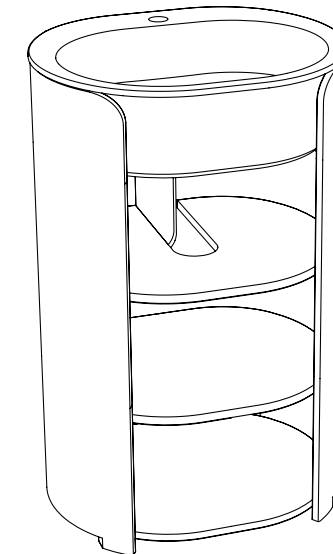

TIBERIO
mobile con lavabo
/ cabinet with washbasin
cm 56 x 48 x 84 h

VASCA BATH TUBE

LIVINGTEC



TALCO



BRINA



ARENARIA

STRUTTURA FRAMEWORK

METALLO / METAL



NERO MATT
/ MATT BLACK



CEMENTO



BRONZO SPAZZOLATO
/ BRUSHED BRONZE

OFELIA, OTTAVIA

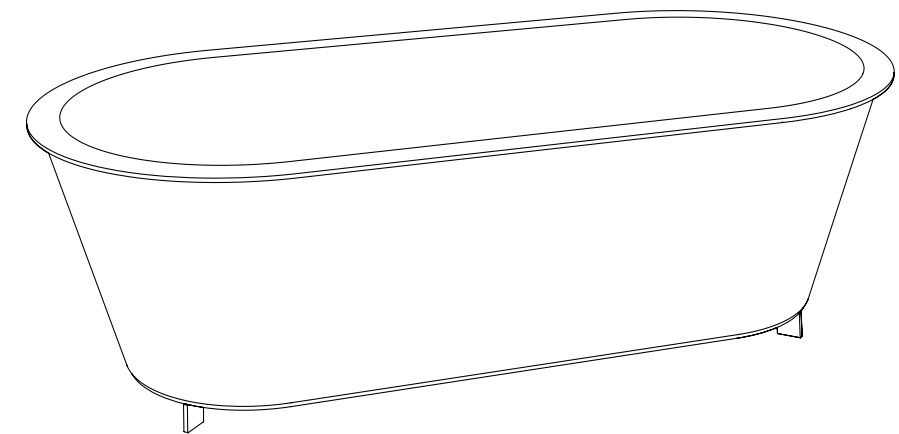
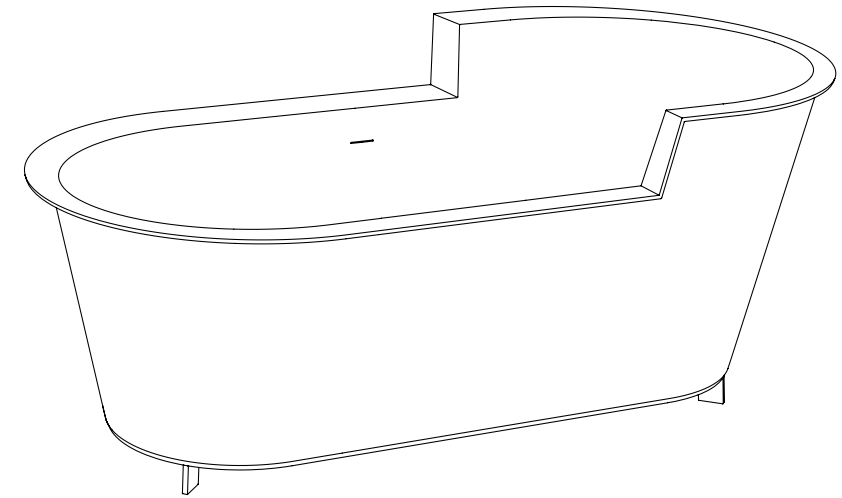

OFELIA
vasca in LivingTec
/ LivingTec bath tub
cm 157 x 93 x 69 h

OTTAVIA
vasca in LivingTec
/ LivingTec bath tub
cm 170 x 80 x 56 h

PIATTO DOCCIA SHOWER TRAY

CERAMICA / CERAMIC
LE ACQUE DI CIELO



CERAMICA / CERAMIC



CERAMICA / CERAMIC
LE TERRE DI CIELO



ASTA DOCCIA SHOWER ROD

METALLO / METAL



L'asta della doccia è regolabile in altezza.
Si consiglia l'utilizzo di n.2 tende larghezza
150 cm e altezza 220/240 cm.

N.B. è consigliabile fare in modo che la
tenda entri nel piatto doccia per almeno
4 cm per evitare la fuoriuscita dell'acqua.

/ The shower rod is height adjustable.
We recommend using 2 curtains 150 cm
wide and 220 or 240 cm high.

N.B. in order to avoid water leakage it is
advisable to make sure that the curtain
hangs inside the shower tray by at least
4 cms.

AUGUSTO

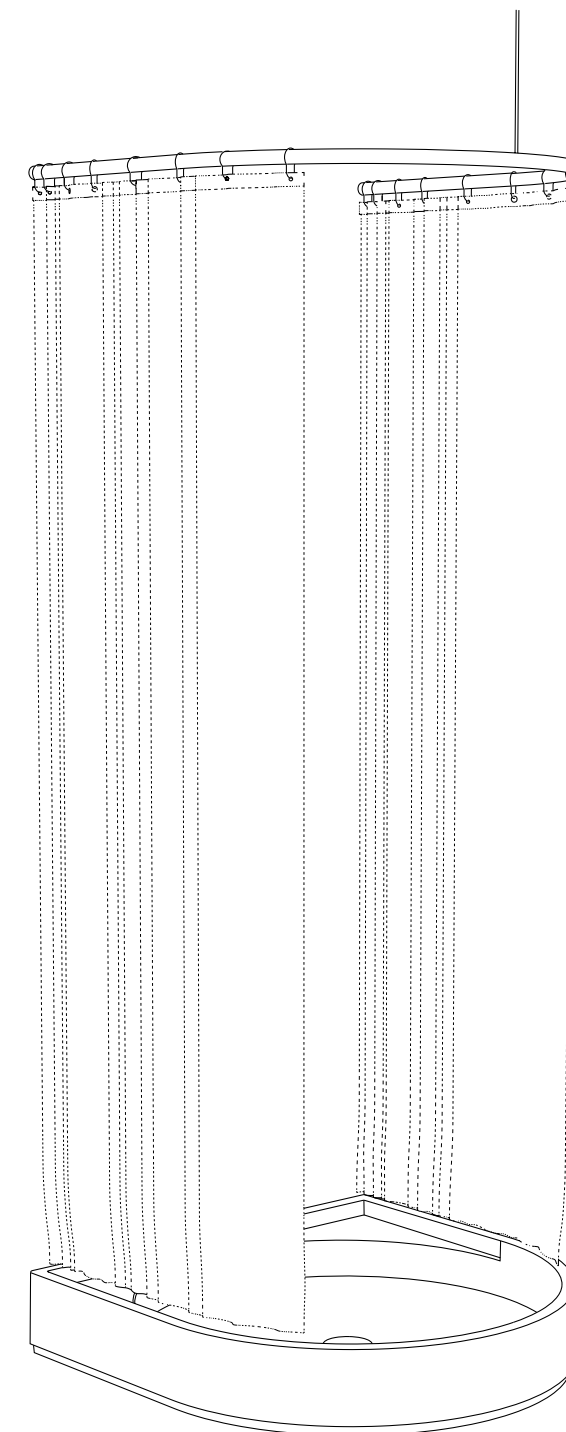

AUGUSTO
piatto doccia con asta
/ shower tray with shower rod
cm 106 x 106 x 20 h

BACINELLE / ON TOP BOWLS

SANITARI / WC AND BIDET

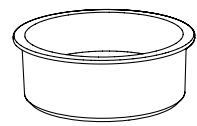

**BACINELLA TONDA
CATINO 45**
Catino round on top bowl 45
cm 45 x 45 x 16 h

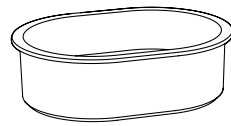

**BACINELLA OVALE
CATINO 55**
Catino oval on top bowl 55
cm 55 x 42 x 16 h



**BACINELLA OVALE
CATINO 65**
Catino oval on top bowl 65
cm 65 x 44 x 16 h

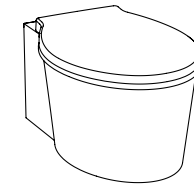

**WC SOSPESO I CATINI
SENZA BRIDA RIMLESS 2.0.1**
I Catini wall-hung wc rimless 2.0.1
cm 56 x 38 x 27 h

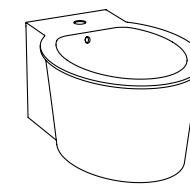

**BIDET SOSPESO I CATINI
MONOFORO**
I Catini wall-hung bidet with 1 hole
cm 56 x 38 x 27 h

CERAMICA / CERAMIC
LE ACQUE DI CIELO



CERAMICA / CERAMIC



CERAMICA / CERAMIC
LE TERRE DI CIELO

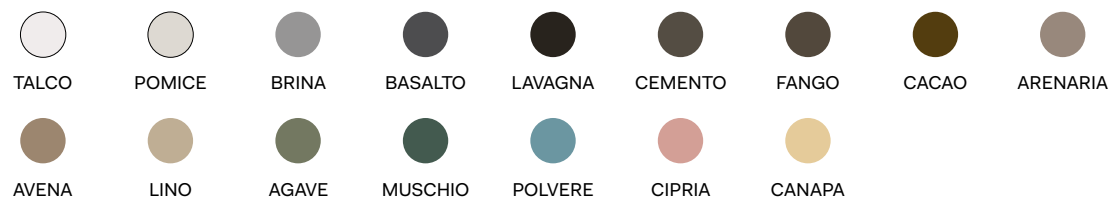

CERAMICA / CERAMIC
LE ACQUE DI CIELO



CERAMICA / CERAMIC



CERAMICA / CERAMIC
LE TERRE DI CIELO



SPECCHI / MIRRORS

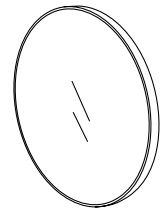

ROUND 60
cm Ø60 x 4

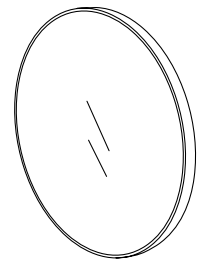

ROUND 75
cm Ø75 x 4

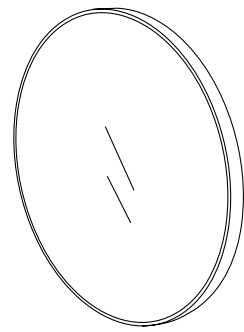

ROUND 120
cm Ø120 x 4

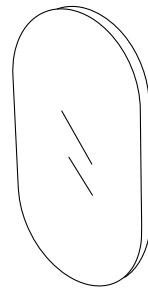

OVAL
cm 90 x 50 x 4 h

LEGNO / WOOD

● NERO MATT / MATT BLACK
● CEMENTO

● BRONZO SPAZZOLATO / BRUSHED BRONZE

SPECCHI CONTENITORI / MIRRORS WITH CABINET

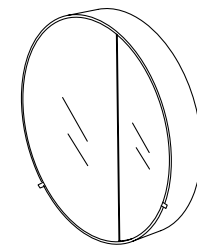

ROUND BOX 75
cm Ø75 x 12

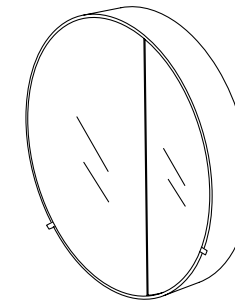

ROUND BOX 90
cm Ø90 x 12

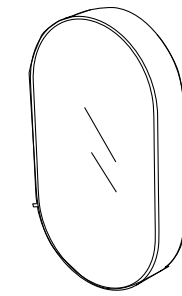

OVAL BOX
cm 50 x 12 x 90 h

LACCATURE / LACQUERING
LE ACQUE DI CIELO

● OLTREMARE ● SMERALDO ● ALGA ● CORALLO ● NINFEA ● ANEMONE

LEGNO / WOOD

● NERO MATT / MATT BLACK
● CEMENTO

● BRONZO SPAZZOLATO / BRUSHED BRONZE

SPECCHI / MIRRORS

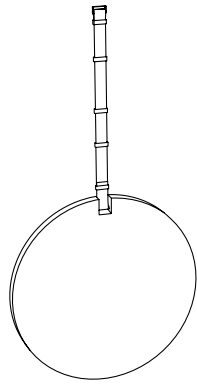

SPECCHIO CON CINTA
specchio (monofacciale
o bifacciale) con cinta
in cuoio
/ mirror (single or double
sided) with leather belt
cm Ø60

**CINTA
BELT**

CUOIO / LEATHER



NERO MATT BIANCO MATT NATURALE
/ MATT BLACK / MATT WHITE / NATURAL

**CORNICE
FRAME**

LEGNO / WOOD



CEMENTO MULTISTRATI
/ PLAYWOOD



Dicembre / December 2022

Ceramica Cielo Spa

A.D.

Andrea Parisio

Giuseppe Pezzano

A.D. Progetto Grafico / Graphic Project

VZNstudio (Nicola Iannibello e Sonia Mion)

Fotografie / Photos

Thomas Pagani

Davide Lovatti (P. 46-47)

Styling

Greta Cevenini

Fotolito e stampa / Photolith and press

Telligraf

© Tutti i diritti sono riservati.

Nessuna parte di questo catalogo può essere riprodotta o trasmessa in qualsiasi forma o con qualsiasi mezzo elettronico, meccanico o altro senza l'autorizzazione scritta dei proprietari dei diritti.

© All rights reserved.

No part of this catalogue may be reproduced or transmitted in any form or by any electronic, mechanical or other means without the written permission of the owners of the rights.

cielo

Ceramica Cielo S.p.A.

Via Falerina Km 7,800

01034 - Fabrica di Roma (VT) Italy

t +39 076156701 \ f +39 0761540363

info@ceramicacielo.it

Spazio Cielo

Via Pontaccio 4 \ 6

20121 - Milano Italy

t +39 0239661165

milano@ceramicacielo.it

www.ceramicacielo.it