

EFFE SOLUTIONS
AND NEW
TECHNOLOGIES
FOR HAMMAMS

STEAM

effe

PERFECT WELLNESS

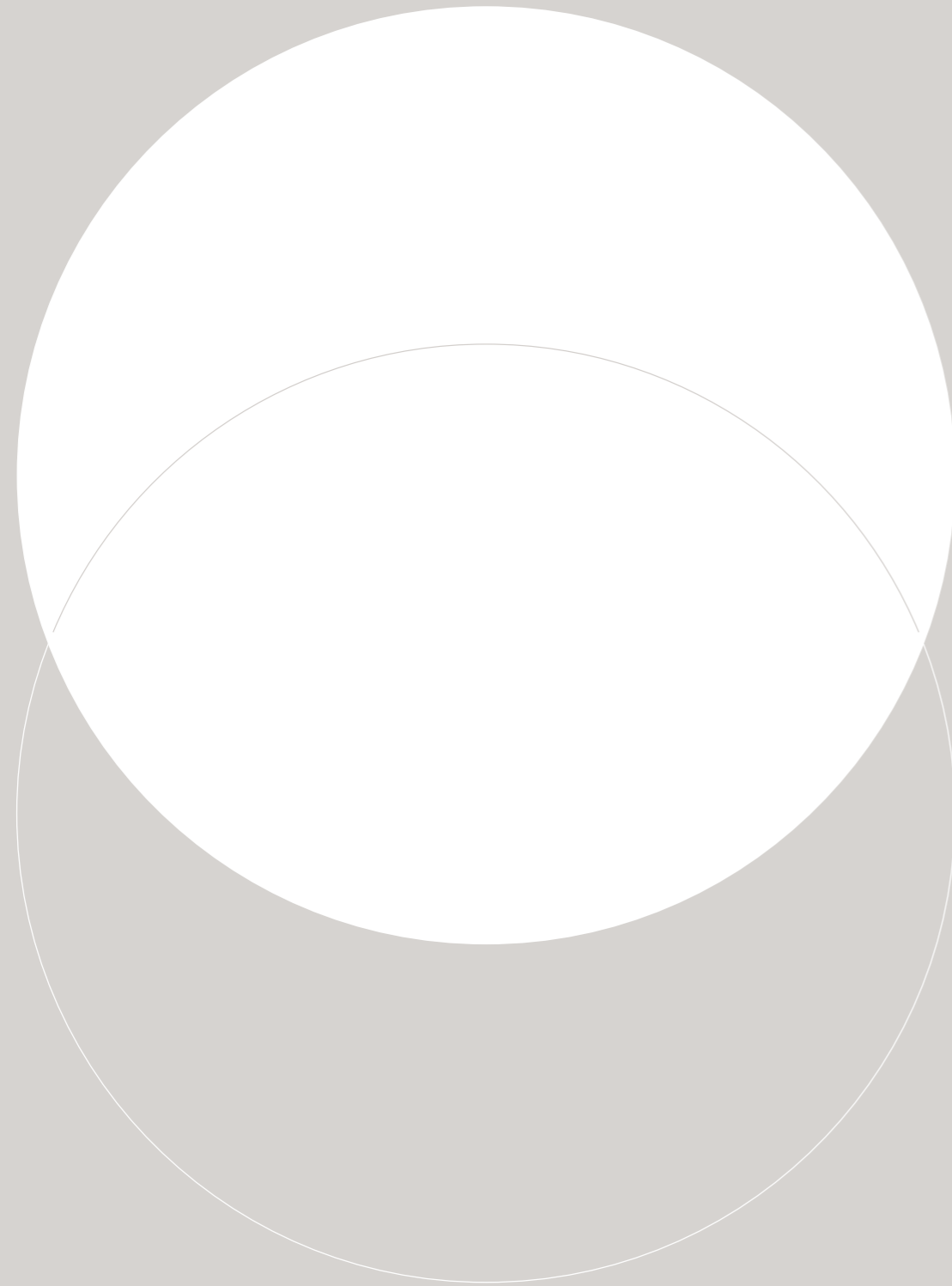

Effe Steam Generators	4
Internal/external steam generator	6
Smart news	10
Best Technology	12
Know-how & features	14

Generatori di vapore Effe	
Generatori di vapore interni/esterni	
Smart news	
Best Technology	
Know-how & funzionalità	

Steam generators:

Nuvola	18
Nuvola Smart Power	22
Easystem Smart	28
Aquasteam Smart	32
Touch&Steam	36

Generatori di vapore:

Nuvola	
Nuvola Smart Power	
Easystem Smart	
Aquasteam Smart	
Touch&Steam	

Doors and glass panels	42
Transform your shower into a Hammam	52
Utility: preparing the Hammam space	56
Basic requirements for a quality Hammam	60

Porte e vetrate	
Trasforma la tua doccia in hammam	
Utility: predisposizione vano hammam	
Elementi basilari per un hammam di qualità	

For over 30 years,
Effe has been
designing and
manufacturing saunas
and Turkish baths
with state-of-the-art
technology

Da oltre 30 anni,
Effe
progetta e produce
saune e bagni turchi
con tecnologie
all'avanguardia

TEMPERATURE 35°C > 48°C

HUMIDITY 90% > 100%

Effe is central to a story that starts with tradition and stretches right into the most innovative future. This is a story of wellbeing, of the ancient traditions of the sauna and the Turkish bath that today's advanced technology and design excellence have clothed in a new guise. This evolution has been made possible by our company that, since 1987, has focused entirely on this sector and we are proud to offer saunas and Turkish baths that are 100% Italian, from design to manufacture.

This philosophy has enabled Effe to become the well-deserved leader in our field, winning the trust of our customers the world over. One of our strong points is the excellence of our high-tech solutions, always in the vanguard of progress with long-lasting, energy-saving products of certified quality, requiring very little maintenance.

In addition to our constant quest for high performance and practicality, we at Effe are fully aware that feeling good equates to looking good and so we take just as much care over aesthetics. Our saunas and Turkish baths feature clean lines traced by such famous designers, often with generous expanses of glass that transform them into stylish items of furniture. We use only eco-friendly materials and the wood is always top quality from reliable sources that do not cause deforestation or endanger rare trees under threat. Effe's extraordinary know-how translates into precise made-to-measure solutions.

Effe è al centro di una storia che parte dalla tradizione e arriva nel futuro più innovativo. La storia è quella del benessere, di antichi riti come la sauna e il bagno turco che oggi assumono una veste contemporanea grazie a tecnologie avanzate e raffinato design. Dietro a questa evoluzione c'è un'azienda che dal 1987 ha dedicato la sua attività unicamente a questo settore, orgogliosa di offrire una produzione di bagni turchi e saune interamente italiana, dalla progettazione alla produzione.

Con questa filosofia Effe è divenuta meritatamente leader nel suo campo, conquistando la fiducia di clienti in tutto il mondo. Un punto di forza è dato dall'eccellenza delle soluzioni tecnologiche, sempre all'avanguardia che garantiscono prodotti di qualità certificata, di lunga durata, con manutenzione ridottissima e risparmio energetico.

Oltre a ricercare elevate prestazioni e funzionalità, Effe sa bene che benessere fa rima con "bell'essere", e quindi pone uguale attenzione anche all'estetica. Saune e bagni turchi sono disegnati con linee pulite, tracciate da illustri designer, spesso con grandi aperture vetrate che le trasformano in eleganti oggetti di arredamento. I materiali sono ecocompatibili, i tipi di legno sono di prima scelta e non provengono da deforestazione o da alberi in estinzione. Lo straordinario know-how di Effe si traduce in accurate soluzioni su misura.

INTERNAL STEAM GENERATORS

GENERATORI DI VAPORE INTERNI

These compact, stylish steam generators are fitted with a backlit touch-screen control panel and are designed to be visible inside the Hammam.

Generatori molto compatti e dal design elegante, dotati di touch control retroilluminati, progettati per essere applicati a vista all'interno del vano hammam.

→ P. 28

EASYTEAM SMART

Hammam size max:
4,5 m³

MODEL MODELLO	VOLUME CUBATURA (M ³)	POWER POTENZA (KW)
30	0 - 3,5	3,0
45	3,5 - 4,5	4,5



→ P. 32

AQUASTEAM SMART

Hammam size max:
4,5 m³

MODEL MODELLO	VOLUME CUBATURA (M ³)	POWER POTENZA (KW)
30	0 - 3,5	3,0
45	3,5 - 4,5	4,5

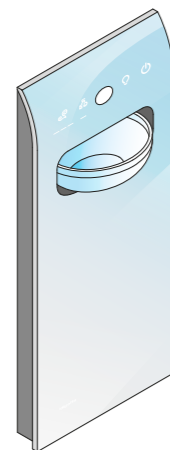

→ P. 36

TOUCH&STEAM

Hammam size max:
9,2 m³

MODEL MODELLO	VOLUME CUBATURA (M ³)	POWER POTENZA (KW)
30	0 - 3,5	3,0
45	3,5 - 4,5	4,5
60	4,5 - 6,2	6,0
90	6,2 - 9,2	9,0



EXTERNAL STEAM GENERATORS

GENERATORI DI VAPORE ESTERNI

These steam generators are designed to be placed in a utility space outside the Hammam. The functions are controlled on a separate control panel.

Generatori progettati per essere collocati al di fuori dell'hammam, in un locale di servizio. La gestione delle funzioni avviene tramite il pannello controllo separato.

→ P. 18

NUVOLA

Hammam size max:
9,2 m³

MODEL MODELLO	VOLUME CUBATURA (M ³)	POWER POTENZA (KW)
25	0 - 2,5	2,5
30	2,5 - 3,5	3,0
45	3,5 - 4,5	4,5
55	4,5 - 5,5	5,5
70	5,5 - 7,2	7,0
90	7,2 - 9,2	9,0

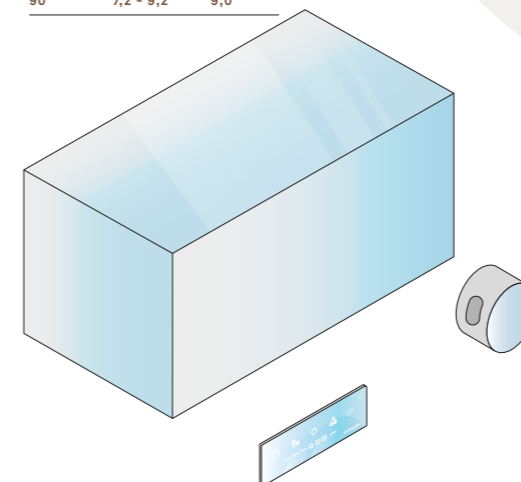

NUVOLA SMART POWER

Hammam size max:
90 m³ +

MODEL MODELLO	VOLUME CUBATURA (M ³)	POWER POTENZA (KW)
25	0 - 2,5	2,5
30	2,5 - 3,5	3,0
45	3,5 - 4,5	4,5
55	4,5 - 5,5	5,5
70	5,5 - 7,2	7,0
90	7,2 - 9,2	9,0
110	9,2 - 12,0	11,0
140	12,0 - 15,0	14,0
180	15,0 - 25,0	18,0
250	25,0 - 35,0	25,0
360	35,0 - 50,0	36,0

→ P. 22

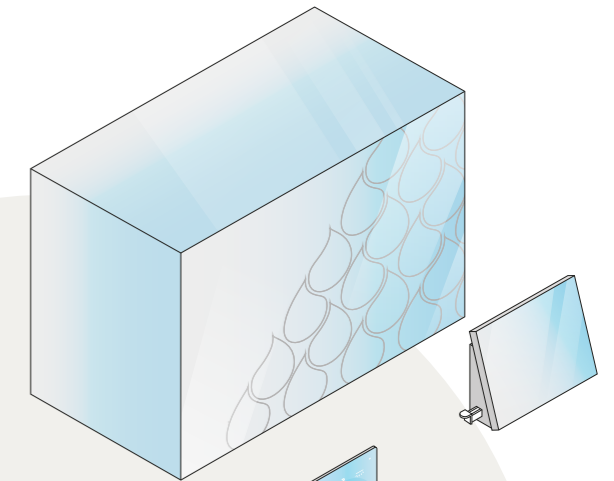

INTERNAL STEAM GENERATOR

GENERATORE DI VAPORE INTERNO

STYLISH

Effe steam generators are compact and stylish, designed to adapt perfectly to almost any environment and décor.

ELEGANZA

I generatori di vapore Effe sono compatti ed eleganti: il design razionale li rende adatti all'applicazione in qualsiasi ambiente.

Touch-screen control panel
Pannello di controllo touch

Built-in steam generator
Generatore ad incasso

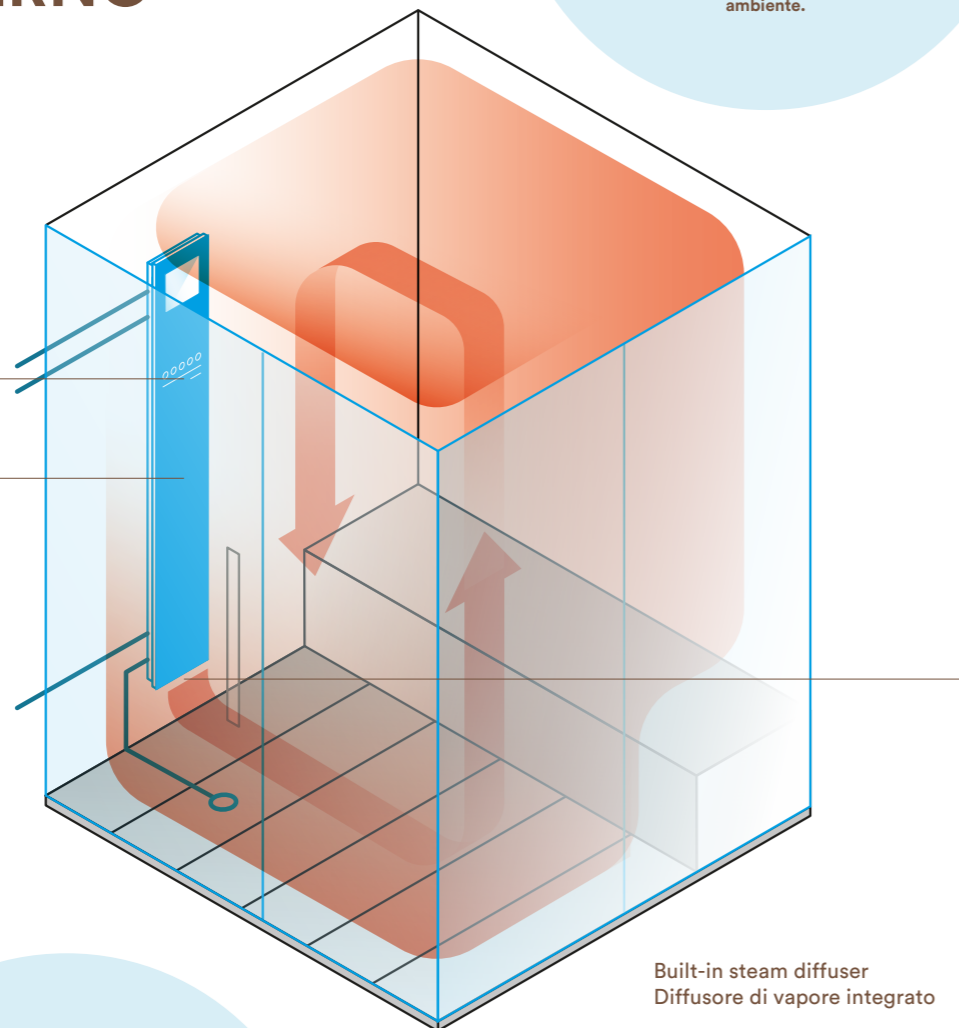
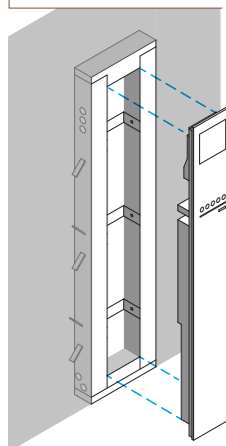

Built-in steam diffuser
Diffusore di vapore integrato

EASY TO INSTALL

Effe supplies a perfectly designed outer casing for quick connection to the water and electrical mains.

FACILITÀ DI INSTALLAZIONE

Effe fornisce una controcassa perfettamente organizzata, per un veloce collegamento alle tubature e alla rete elettrica.

External steam generator
Generatore di vapore esterno

EXTERNAL STEAM GENERATOR

GENERATORE DI VAPORE ESTERNO

POWERFUL

The external Nuvola steam generator enables more power to be used in very large spaces.

POTENZA

Il generatore di vapore esterno Nuvola permette l'utilizzo di potenze più elevate e quindi l'impiego per spazi molto ampi.

Steam diffuser
Diffusore di vapore

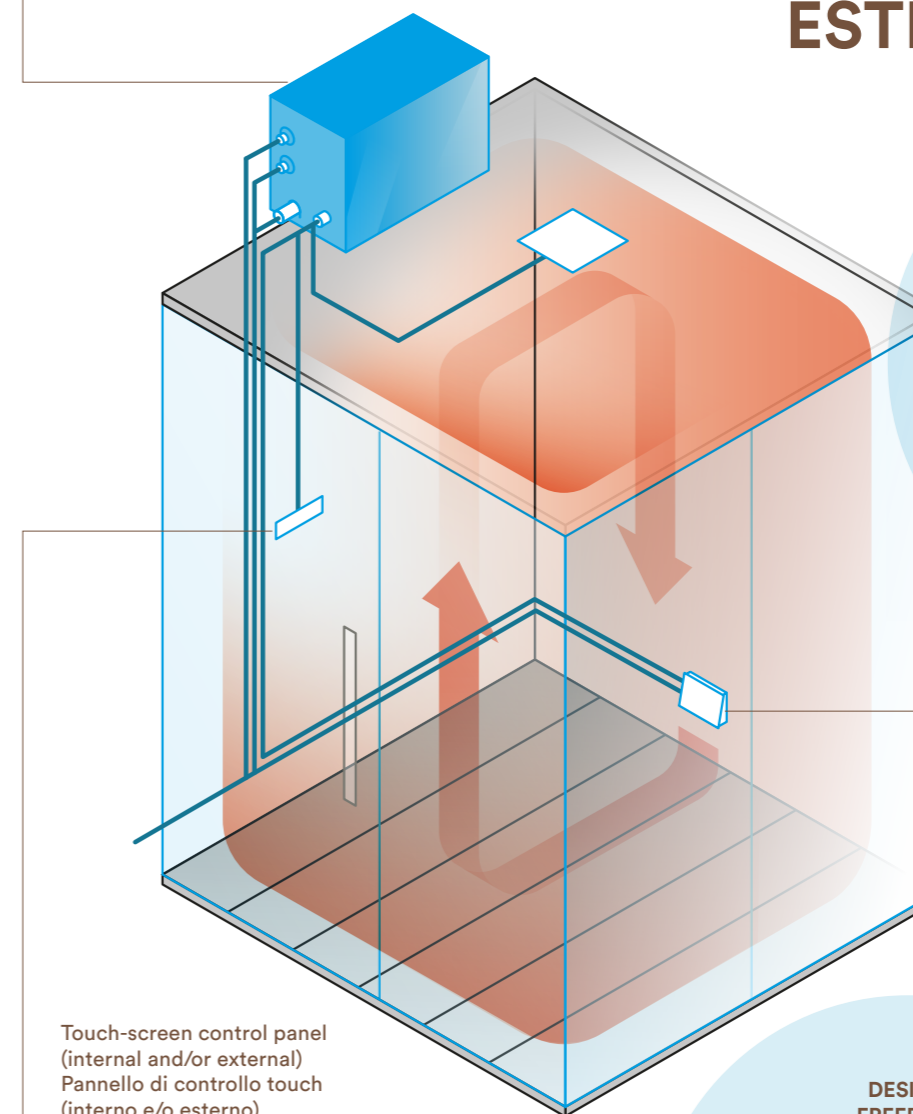

Touch-screen control panel
(internal and/or external)
Pannello di controllo touch
(interno e/o esterno)

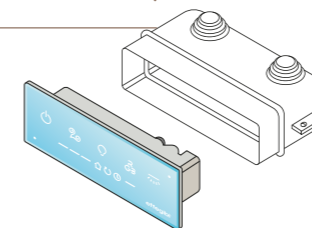

DESIGN FREEDOM

The external generator can be installed in a hidden space, for total Hammam design freedom.

PULIZIA FORMALE

Il generatore esterno può essere installato in un vano nascosto, lasciando completa libertà nel design dell'hammam.

BEST STEAM EXPERIENCE

BY **effe**



Every Effe boiler has a washing cycle that removes all impurities from the water to ensure the steam is pure, light and healthy to breathe.

I cicli di lavaggio delle caldaie Effe eliminano ogni impurità dell'acqua, generando un vapore puro, leggero e sano da respirare.

Only when steam is pure does it feel so good on our body: our skin absorbs the warm water vapour, becoming softer and regenerated.

Solo un vapore puro permette un'appagante percezione di contatto sul nostro corpo: la pelle assorbe il caldo vapore acqueo, ammorbidendosi e rigenerandosi.



PERFECT STEAM,
PURE
BREATHING



ENCHANTING
BODY

360°
WARM
WELLBEING



EXCLUSIVE
TECHNOLOGY
BY EFFE



Dense, pure and evenly distributed steam in heat: this is what makes a Hammam such a unique and unforgettable experience. Only Effe can guarantee perfect steam over time, thanks to sophisticated technologies developed in-house over the years.

Vapore denso, puro e uniforme nel calore: ecco come il rito dell'Hammam diventa un'esperienza unica e indimenticabile. Solo Effe riesce a garantire un vapore perfetto nel tempo, grazie a sofisticate tecnologie sviluppate internamente in anni di esperienza.

The exclusive Power Steam function, a standard feature of all Effe steam generators, ensures the steam circulates correctly and the temperature is distributed evenly throughout the Hammam.

L'esclusiva funzione Power Steam, di serie su tutti i generatori di vapore Effe, garantisce la corretta circolazione del vapore e quindi la distribuzione uniforme della temperatura in tutto il vano hammam.

SMART NEWS

THE NEW SMART STEAM GENERATORS BY EFFE FEATURE THE BEST IN DESIGN, TECHNOLOGY AND RESPECT FOR THE ENVIRONMENT.

I NUOVI MODELLI SMART DI GENERATORI DI VAPORE EFFE OFFRONO LE MIGLIORI PRESTAZIONI PER DESIGN, TECNOLOGIA E TUTELA DELL'AMBIENTE.

1

ENERGY SAVINGS
RISPARMIO ENERGETICO

The temperature control probes regulate the emission of the steam to ensure maximum comfort at all times.

Le sonde di controllo della temperatura regolano l'erogazione del vapore per ottenere sempre il massimo confort.

The on/off periods of the heating elements are evenly spaced.

Distribuzione uniforme nel tempo dei cicli di accensione e spegnimento delle termoresistenze.

2

EASY TO INSTALL
FACILITÀ DI INSTALLAZIONE



The casing is designed for easy installation.

Controcassa progettata per agevolare i processi di installazione.

A special top cover is fitted on all the internal generators to prevent dripping.

In tutti i generatori interni, uno specifico carter superiore garantisce l'anti-gocciolamento.

The casing and internal generators are perfectly watertight.

Perfetta tenuta stagna della controcassa e dei generatori interni.

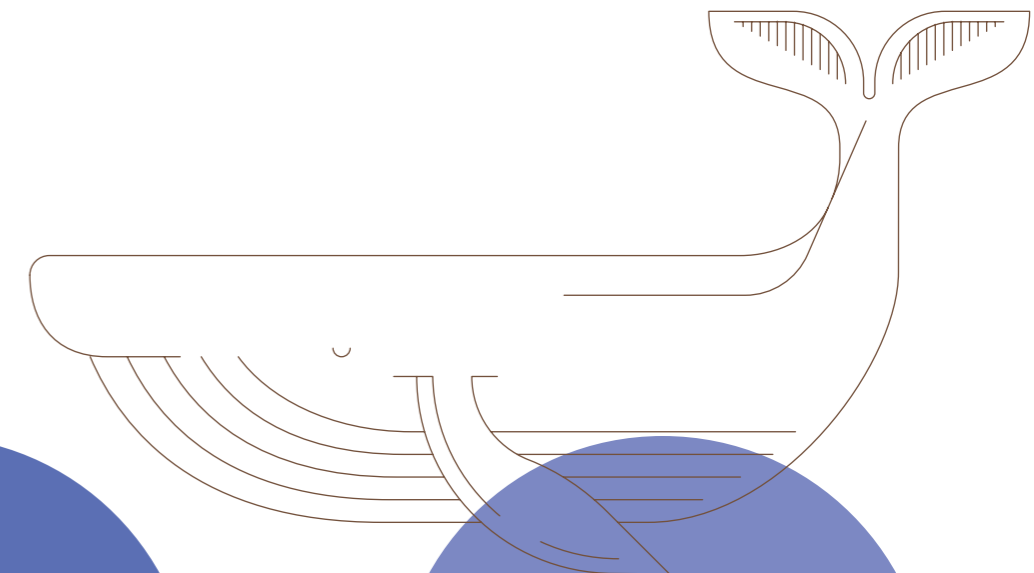

3

SMART DESCALING
DECALCIFICAZIONE INTELLIGENTE

It automatically checks for and reduces problems caused by the build-up of lime-scale and other substances in the water.

Controllo automatico e riduzione dei fenomeni derivanti da concentrazione di calcio ed altre sostanze in acqua.

Final automatic rinsing takes place 30 min after the end of the Hammam session with initial dilution with cold water.

Risciaquo automatico finale 30 min dopo la fine dell'hammam con diluizione iniziale con acqua fredda.

4

NO WATER WASTE
NESSUNO SPRECO DI ACQUA

Dilution and intermediate rinsing are based on real need.

Diluizioni e risciacqui intermedi calcolati su reale fabbisogno.

The boiler is automatically filled when needed.

Riempimento automatico della caldaia in base alle necessità.

The time needed to fill and drain water is constantly monitored.

Monitoraggio costante del tempo di carico e scarico acqua.

Compliance with anti-pollution plumbing requirements.

Conformità ai requisiti anti-inquinamento per allaccio idrico.

BEST TECHNOLOGY

5

ELECTRONIC SELF-CONFIGURATION
AUTO-CONFIGURAZIONE ELETTRONICA

Automatic start-up: thanks to the sophisticated electronics, start-up is quick and there is no need for the manual procedure.

Start-up automatico: la sofisticata elettronica consente di svolgere velocemente lo start-up evitando la procedura manuale.

The system automatically recognises any connected devices (colour therapy lamp, control panel etc.).

Il sistema riconosce automaticamente le periferiche collegate (lampada cromo, pannello, ecc.).

6

PERFECT STEAM
VAPORE PERFETTO

PSF
 POWER STEAM
 FUNCTION



Power Steam Function (PSF) fitted standard: a special ventilation system that avoids temperature differences inside the Hammam cubicle.

Funzione Power Steam (PSF) di serie: speciale sistema di ventilazione che consente una temperatura uniforme in tutto il vano hammam.

Adjustable blades to vary steam flow direction; configurable fan speed; LED lighting illuminates the steam outlet.

Alette orientabili per direzionare il vapore in uscita; velocità ventola configurabile; led luminoso all'uscita del vapore.

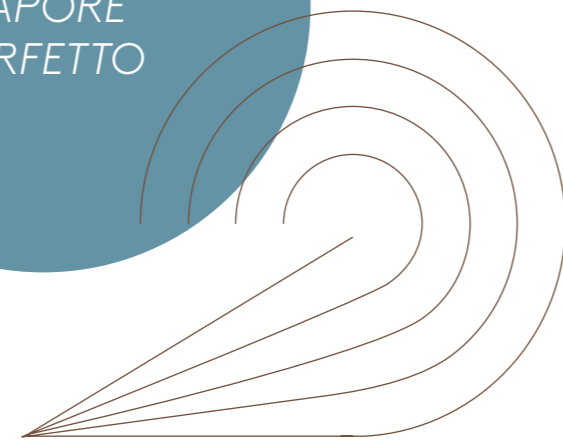

Two temperature probes inside the steam diffuser.

Doppia sonda di temperatura all'interno del diffusore di vapore.

Super Silent Steam: silent steam generation.

Super Silent Steam: basso livello di rumorosità dell'erogazione vapore.

BETTER MAINTENANCE
MIGLIORE MANUTENZIONE

7

The system is able to detect and signal malfunctions in the heating elements and probe.

Sistema in grado di rilevare e segnalare eventuali malfunzionamenti delle termoresistenze e della sonda.

Self-diagnosis: in the event of a fault, the system unblocks the valves.

Autodiagnosi: in caso di anomalia il sistema effettua una procedura di ripristino delle elettrovalvole.



Effe steam generators are designed and built in compliance with the leading international certification bodies.

I generatori di vapore Effe sono progettati e costruiti in conformità con i principali enti di certificazione mondiali.

8

WORLDWIDE CERTIFICATIONS
CERTIFICAZIONE DEI PRINCIPALI ENTI MONDIALI



KNOW-HOW & FEATURES



SEC SMART ENERGY CONTROL

Evenly spaced on/off periods for the heating elements to obtain even steam distribution throughout the session.

Distribuzione uniforme nel tempo dei cicli di accensione e spegnimento delle termoresistenze in modo da ottenere una diffusione costante del vapore.



SBC SMART BOILER CLEANING

Dilution and intermediate rinsing processes not time controlled but based on real need to reduce limescale deposits and avoid frequent boiler maintenance.

Diluizioni e risciacqui intermedi calcolati sul reale fabbisogno per ridurre l'accumulo di calcare e aumentare la durata della caldaia senza manutenzione.



SWF SMART WATER FILLING

Optimised management of boiler filling, intermediate rinsing and emptying process. Heating elements programmed for optimum operation.

Gestione ottimizzata di riempimento caldaia, risciacqui intermedi e svuotamento. Le resistenze lavorano sempre in maniera ottimale.



RWF REGULATING WATER FLOW

The generator can work on a wide range of water systems with different pressures, from 0.2 bar to 10 bar.

Il generatore può lavorare dentro un ampio range di pressione dell'impianto idrico del locale: da 0,2 bar a 10 bar.



ECC EFFE COMFORT CONTROL

This system is built into the Effe steam generator, enabling remote control of the Turkish bath from a tablet or smartphone using the Effe Experience My Hammam app.

Il sistema è integrato nel generatore di vapore Effe e consente di gestire a distanza il bagno turco tramite App "Effe Experience" su tablet o smartphone.

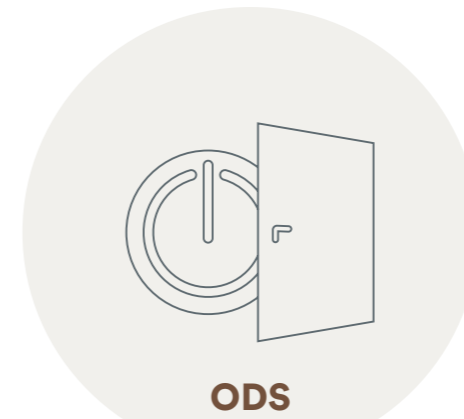

ODS OPEN DOOR SENSOR

The system automatically interrupts steam distribution when the door of the Hammam is left open for a long time.

Il sistema è in grado di bloccare automaticamente l'erogazione del vapore in caso di prolungata apertura della porta del vano hammam.



PSF POWER STEAM FUNCTION

The innovative ventilation management system minimises temperature layering inside the cubicle by controlling ventilation.

L'innovativo sistema di gestione della ventilazione minimizza la stratificazione delle temperature all'interno della cabina, grazie ad una ventilazione controllata.





NUVOLA

Nuvola and Nuvola Smart Power are the professional line of Effe external steam generators: power, reliability and elegant design for your wellbeing

Nuvola e Nuvola Smart Power sono la linea di generatori esterni professionali Effe: potenza, affidabilità ed eleganza al servizio del tuo benessere



SBC
SMART
BOILER
CLEANING



SWF
SMART
WATER
FILLING



RWF
REGULATING
WATER
FLOW



1

Nuvola: the professional external steam generator, for volumes up to 9,2m³

Nuvola: generatore di vapore professionale esterno, per cubature fino a 9,2 m³

2

The steam-control technology ensures excellent hygiene and no lime-scale build-up

La tecnologia di controllo del vapore assicura igiene e purificazione dal calcare

3

Automatic heating element control for even steam distribution over time

Controllo automatico delle termoresistenze per una distribuzione di vapore uniforme nel tempo

4

Touch-screen control panel with backlit icons and temperature indicator

Pannello di controllo touch con icone retroilluminate e indicatore del livello di temperatura

5

Set up for connection to a white or chromotherapy light fitting

Predisposizione per collegamento a lampada con luce bianca o cromoterapia

6

SWF (Smart Water Filling) function: optimised management of boiler filling, intermediate rinsing and emptying process

Funzione SWF (Smart Water Filling): gestione ottimizzata di riempimento caldaia, risciacqui intermedi e svuotamento

7

Nuvola is easy to install and reliable over time

Nuvola è semplice da installare e affidabile nel tempo

STEAM GENERATOR DIMENSIONS
CM 52 X 26 X 27 H

CONTROL PANEL DIMENSIONS
MOUNTING BOX:
CM 16 X 7 X 4,5 H
CONTROL PANEL:
CM 16,5 X 5 H

STEAM DIFFUSER
CM 70 X 3,5

- STEAM GENERATOR FEATURES**
- RWF REGULATING WATER FLOW: CAN WORK ON A WIDE RANGE OF WATER SYSTEMS WITH DIFFERENT PRESSURES;
 - SWF SMART WATER FILLING: OPTIMISED MANAGEMENT OF BOILER FILLING;
 - SBC SMART BOILER CLEANING: DILUTION AND INTERMEDIATE RINSING PROCESSES NOT TIME CONTROLLED BUT BASED ON REAL NEED;
 - PANEL WITH BACKLIT ICONS AND TEMPERATURE GAUGE.

STEAM DIFFUSER FEATURES

- ESSENTIAL OILS CONTAINER.

MODEL	VOLUME (M ³)	POWER (KW)
25	0 - 2,5	2,5
30	2,5 - 3,5	3,0
45	3,5 - 4,5	4,5
55	4,5 - 5,5	5,5
70	5,5 - 7,2	7,0
90	7,2 - 9,2	9,0

DIMENSIONI GENERATORE
CM 52 X 26 X 27 H

DIMENSIONI PANNELLO DI CONTROLLO
SCATOLA DA INCASSO:
CM 16 X 7 X 4,5 H
PANNELLO:
CM 16,5 X 5 H

DIFFUSORE DI VAPORE
CM 70 X 3,5

- GENERATORE DI VAPORE CARATTERISTICHE**
- RWF REGULATING WATER FLOW: AUTOREGOLAZIONE ALLA PRESSIONE DELL'IMPIANTO IDRICO;
 - SWF SMART WATER FILLING: GESTIONE OTTIMIZZATA DI RIEMPIMENTO CALDAIA;
 - SBC SMART BOILER CLEANING: DILUZIONI E RISCACQUI INTERMEDI SUL REALE FABBISOGNO;
 - PANNELLO DI CONTROLLO TOUCH CON ICONE RETROILLUMINATE E INDICATORE DEL LIVELLO DI TEMPERATURA.

DIFFUSORE DI VAPORE CARATTERISTICHE

- CONTENITORE PER ESSENZE.

MODELLO	CUBATURA (M ³)	POTENZA (KW)
25	0 - 2,5	2,5
30	2,5 - 3,5	3,0
45	3,5 - 4,5	4,5
55	4,5 - 5,5	5,5
70	5,5 - 7,2	7,0
90	7,2 - 9,2	9,0

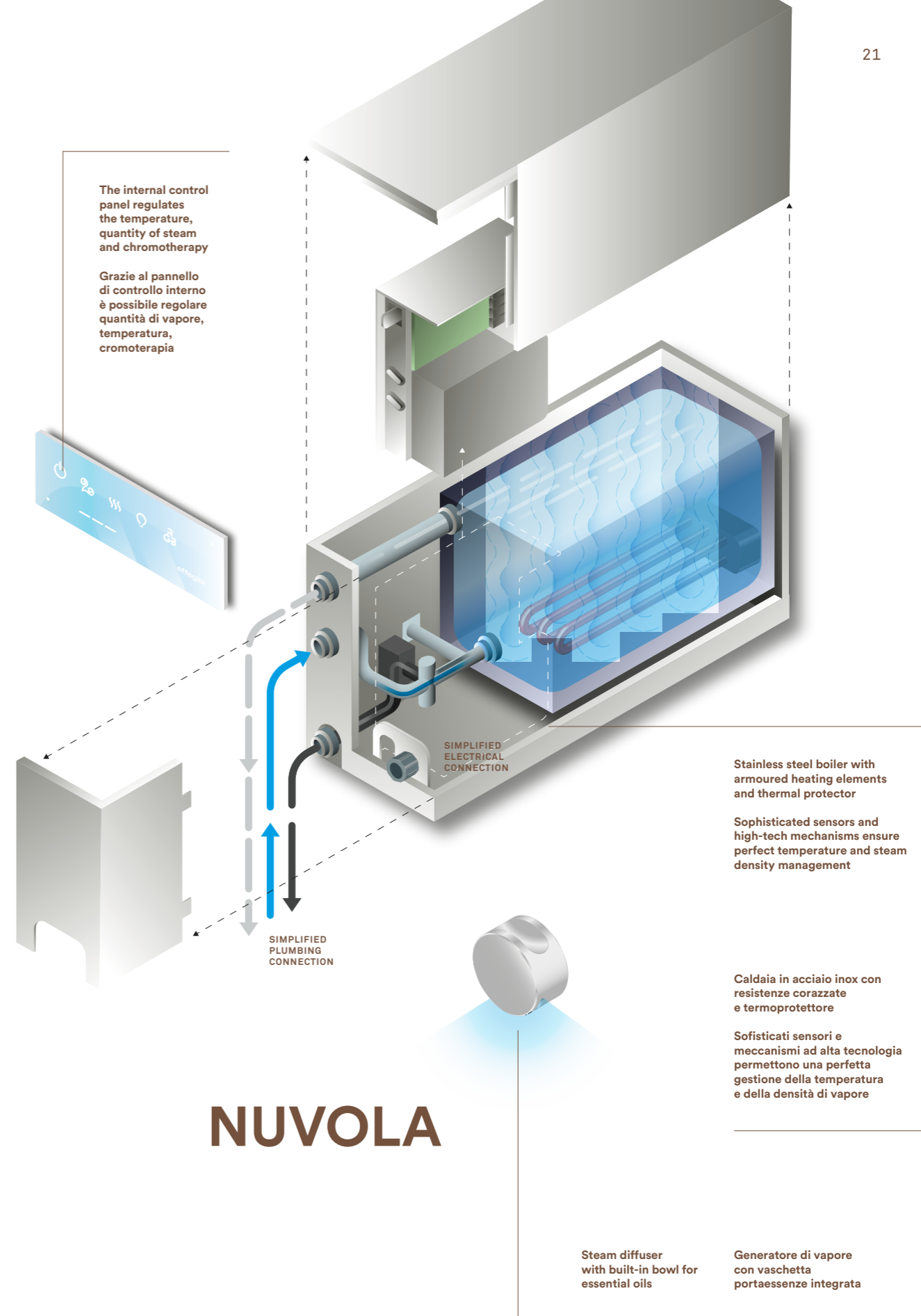



Nuvola Smart Power
with Tuttovetro Inside door,
built-in frame

NUVOLA SMART POWER

This high-power steam generator is fitted outside the Hammam: using the most sophisticated technology available and featuring clean, crisp lines, Nuvola Smart Power is a truly unbeatable product.

Generatore di vapore ad alta potenza, da collocare all'esterno dello spazio hammam: la più sofisticata tecnologia esistente e la pulizia formale fanno di Nuvola Smart Power un prodotto senza rivali



PSF
POWER
STEAM
FUNCTION



SEC
SMART
ENERGY
CONTROL



SBC
SMART
BOILER
CLEANING



SWF
SMART
WATER
FILLING



RWF
REGULATING
WATER
FLOW



ECC
EFFE
COMFORT
CONTROL



ODS
OPEN
DOOR
SENSOR



1

Nuvola Smart Power: external professional-standard steam generator suitable for large spaces

Nuvola Smart Power: generatore di vapore professionale esterno, adatto per ampie cubature

2

Tested for long maintenance-free operation

Prolungato funzionamento senza bisogno di manutenzione

3

Nuvola Smart Power has been developed for hidden installation, to blend perfectly with any interior design solution

Nuvola Smart Power è adatto per applicazioni a scomparsa e si integra quindi facilmente con qualsiasi soluzione d'arredo

4

Automatic heating element control for even steam distribution over time

Controllo automatico delle termoresistenze per una distribuzione di vapore uniforme nel tempo

5

Touch-screen control panel with backlit icons and temperature indicator

Pannello di controllo touch con icone retroilluminate e indicatore del livello di temperatura

6

PSF (Power Steam Function): the innovative ventilation management system minimises temperature layering

PSF (Power Steam Function): innovativo sistema di ventilazione che minimizza la stratificazione delle temperature

7

SWF (Smart Water Filling) function: optimised management of boiler filling, intermediate rinsing and emptying process

Funzione SWF (Smart Water Filling): gestione ottimizzata di riempimento caldaia, risciacqui intermedi e svuotamento

8

The ECC (Effe Comfort Control) function enables the Turkish bath to be managed remotely from a tablet or smartphone

Funzione ECC (Effe Comfort Control): il sistema consente di gestire a distanza il bagno turco da tablet o smartphone

9

Set up for connection to a white or chromotherapy light fitting

Predisposizione per collegamento a lampada con luce bianca o cromoterapia

STEAM GENERATOR DIMENSIONS
CM 52 X 26 X 27 H
CM 52 X 26 X 45 H (MOD. 110-140-180)
CM 52 X 26 X 95 H (MOD. 250-360)

CONTROL PANEL DIMENSIONS
MOUNTING BOX:
CM 19 X 8 X 4,3 H
CONTROL PANEL:
CM 18 X 6 H

STEAM DIFFUSER
MOUNTING BOX:
CM 18 X 10 X 15,2 H
STEAM DIFFUSER:
CM 18,2 X 4,5 X 12,3 H

STEAM GENERATOR FEATURES:

- RWF REGULATING WATER FLOW: CAN WORK ON A WIDE RANGE OF WATER SYSTEMS WITH DIFFERENT PRESSURES;
- SWF SMART WATER FILLING: OPTIMISED MANAGEMENT OF BOILER FILLING;
- SBC SMART BOILER CLEANING: DILUTION AND INTERMEDIATE RINSING PROCESSES NOT TIME CONTROLLED BUT BASED ON REAL NEED;
- SEC SMART ENERGY CONTROL: EVENLY SPACED ON/OFF PERIODS FOR THE HEATING ELEMENTS;
- ODS OPEN DOOR SENSOR;
- TOUCH-SCREEN CONTROL PANEL WITH BACKLIT ICONS AND TEMPERATURE GAUGE.

STEAM DIFFUSER FEATURES:

- ADJUSTABLE FLAPS TO CONTROL THE OUTGOING STEAM DIRECTION;
- CUBICLE AIR-RECIRCULATION SYSTEM BUILT INTO THE WATER-RESISTANT FAN;
- ESSENTIAL OILS CONTAINER;
- STEAM OUTPUT LED LIGHT;
- ADDITIONAL TEMPERATURE PROBE INSIDE THE DIFFUSER.

ECC - EFFE COMFORT CONTROL
THIS SYSTEM IS BUILT INTO THE EFFE STEAM GENERATOR, ENABLING REMOTE CONTROL OF THE TURKISH BATH FROM A TABLET OR SMARTPHONE USING THE EFFE EXPERIENCE APP.

MODEL	VOLUME (M ³)	POWER (KW)
25	0 - 2,5	2,5
30	2,5 - 3,5	3,0
45	3,5 - 4,5	4,5
55	4,5 - 5,5	5,5
70	5,5 - 7,2	7,0
90	7,2 - 9,2	9,0
110	9,2 - 12,0	11,0
140	12,0 - 15,0	14,0
180	15,0 - 25,0	18,0
250	25,0 - 35,0	25,0
360	35,0 - 50,0	36,0

DIMENSIONI GENERATORE
CM 52 X 26 X 27 H
CM 52 X 26 X 45 H (MOD. 110-140-180)
CM 52 X 26 X 95 H (MOD. 250-360)

DIMENSIONI PANNELLO DI CONTROLLO
SCATOLA DA INCASSO:
CM 19 X 8 X 4,3 H
PANNELLO:
CM 18 X 6 H

DIFFUSORE DI VAPORE
CONTROCASSA:
CM 18 X 10 X 15,2 H
DIFFUSORE:
CM 18,2 X 4,5 X 12,3 H

GENERATORE DI VAPORE CARATTERISTICHE:

- RWF REGULATING WATER FLOW: AUTOREGOLAZIONE ALLA PRESSIONE DELL'IMPIANTO IDRICO;
- SWF SMART WATER FILLING: GESTIONE OTTIMIZZATA DI RIEMPIMENTO CALDAIA;
- SBC SMART BOILER CLEANING: DILUZIONI E RISCACQUI INTERMEDI SUL REALE FABBISOGNO;
- SEC SMART ENERGY CONTROL: DISTRIBUZIONE UNIFORME NEL TEMPO, DEI CICLI DI ACCENSIONE E SPEGNIMENTO DELLE TERMORESISTENZE;
- ODS OPEN DOOR SENSOR: SENSORE PORTA APERTA;
- PANNELLO DI CONTROLLO TOUCH CON ICONE RETROILLUMINATE E INDICATORE DEL LIVELLO DI TEMPERATURA.

DIFFUSORE DI VAPORE CARATTERISTICHE:

- ALETTE ORIENTABILI PER DIREZIONARE IL VAPORE;
- SISTEMA DI RICIRCOLO DELL'ARIA IN CABINA CON VENTILATORE WATER RESISTANT;
- CONTENITORE PER ESSENZE;
- LED LUMINOSO ALL'USCITA DEL VAPORE;
- SONDA DI TEMPERATURA AGGIUNTIVA.

ECC - EFFE COMFORT CONTROL
IL SISTEMA È INTEGRATO NEL GENERATORE DI VAPORE EFFE E CONSENTE DI GESTIRE A DISTANZA IL BAGNO TURCO TRAMITE APP "EFFE EXPERIENCE" SU TABLET O SMARTPHONE.

MODELLO	CUBATURA (M ³)	POTENZA (KW)
25	0 - 2,5	2,5
30	2,5 - 3,5	3,0
45	3,5 - 4,5	4,5
55	4,5 - 5,5	5,5
70	5,5 - 7,2	7,0
90	7,2 - 9,2	9,0
110	9,2 - 12,0	11,0
140	12,0 - 15,0	14,0
180	15,0 - 25,0	18,0
250	25,0 - 35,0	25,0
360	35,0 - 50,0	36,0

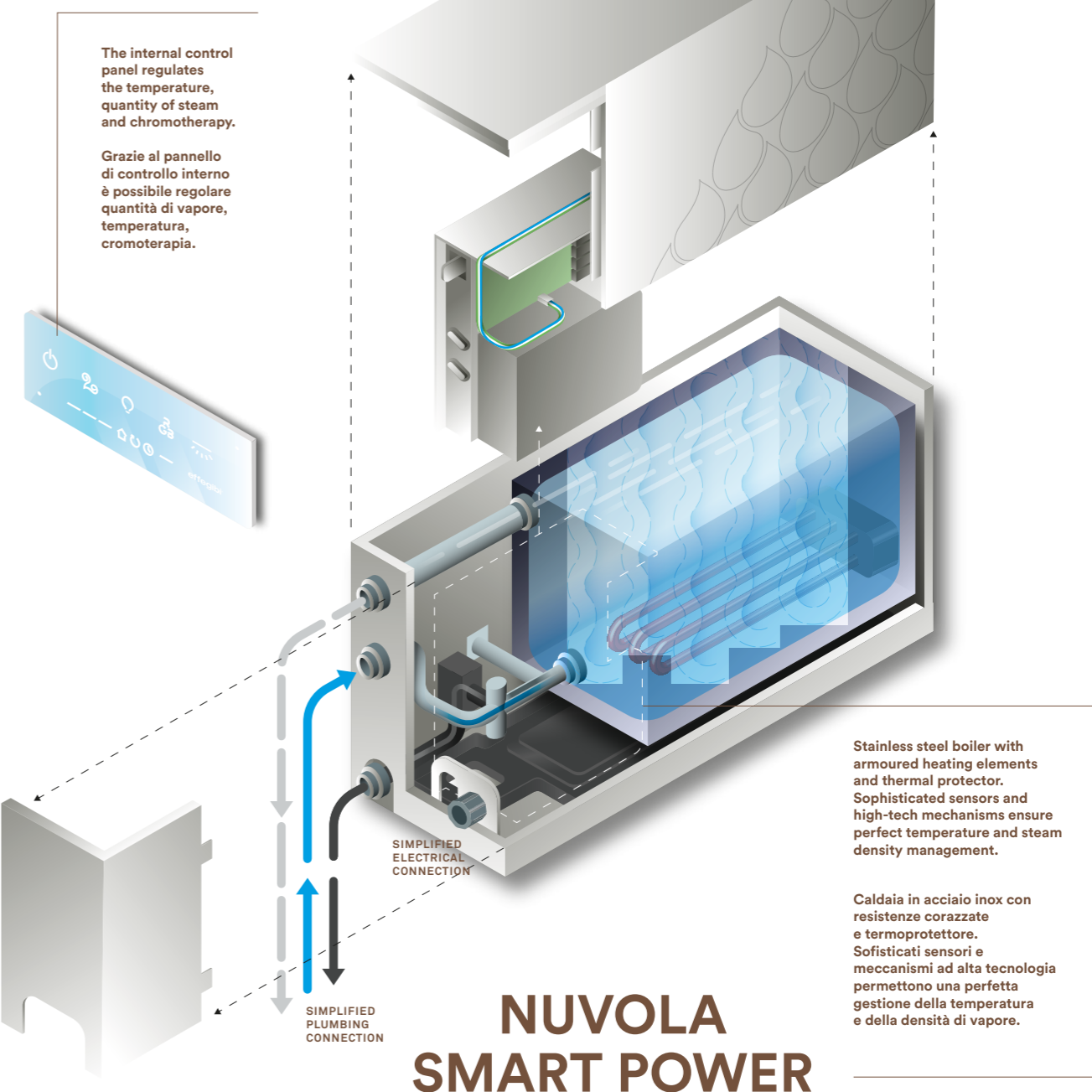

The internal control panel regulates the temperature, quantity of steam and chromotherapy.

Grazie al pannello di controllo interno è possibile regolare quantità di vapore, temperatura, cromoterapia.

Stainless steel boiler with armoured heating elements and thermal protector. Sophisticated sensors and high-tech mechanisms ensure perfect temperature and steam density management.

Caldaia in acciaio inox con resistenze corazzate e termostato. Sofisticati sensori e meccanismi ad alta tecnologia permettono una perfetta gestione della temperatura e della densità di vapore.

NUVOLA SMART POWER

The steam diffuser is fitted with the Power Steam Function (PSF), a ventilation system that avoids temperature layering inside the Hammam cubicle. The diffuser is fitted with adjustable blades to vary the direction of the steam flow.

L'erogatore è dotato del sistema Power Steam (PSF) per la ventilazione del vapore: questa funzione evita la stratificazione della temperatura all'interno del vano hammam. Nell'erogatore sono inserite delle ali regolabili per variare la direzione del flusso di vapore.

The LED light illuminating the steam outlet creates a magical effect.

Un magico effetto grazie alla luce LED che illumina l'uscita del vapore.



www.ffe.it/en/product/nuvola-smartpower/
#video



www.ffe.it/prodotto/nuvola-smartpower/
#video



Nuvola Smart Power
with Tuttovetro Inside door,
built-in frame



EASYSTEAM SMART

A stylish, compact steam generator, Easystem is easy to install, high-tech and user-friendly

Generatore di vapore elegante e compatto, Easystem abbina semplicità di installazione e utilizzo con elevata tecnologia



PSF
POWER
STEAM
FUNCTION



SEC
SMART
ENERGY
CONTROL



SBC
SMART
BOILER
CLEANING



SWF
SMART
WATER
FILLING



RWF
REGULATING
WATER
FLOW



ECC
EFFE
COMFORT
CONTROL



ODS
OPEN
DOOR
SENSOR

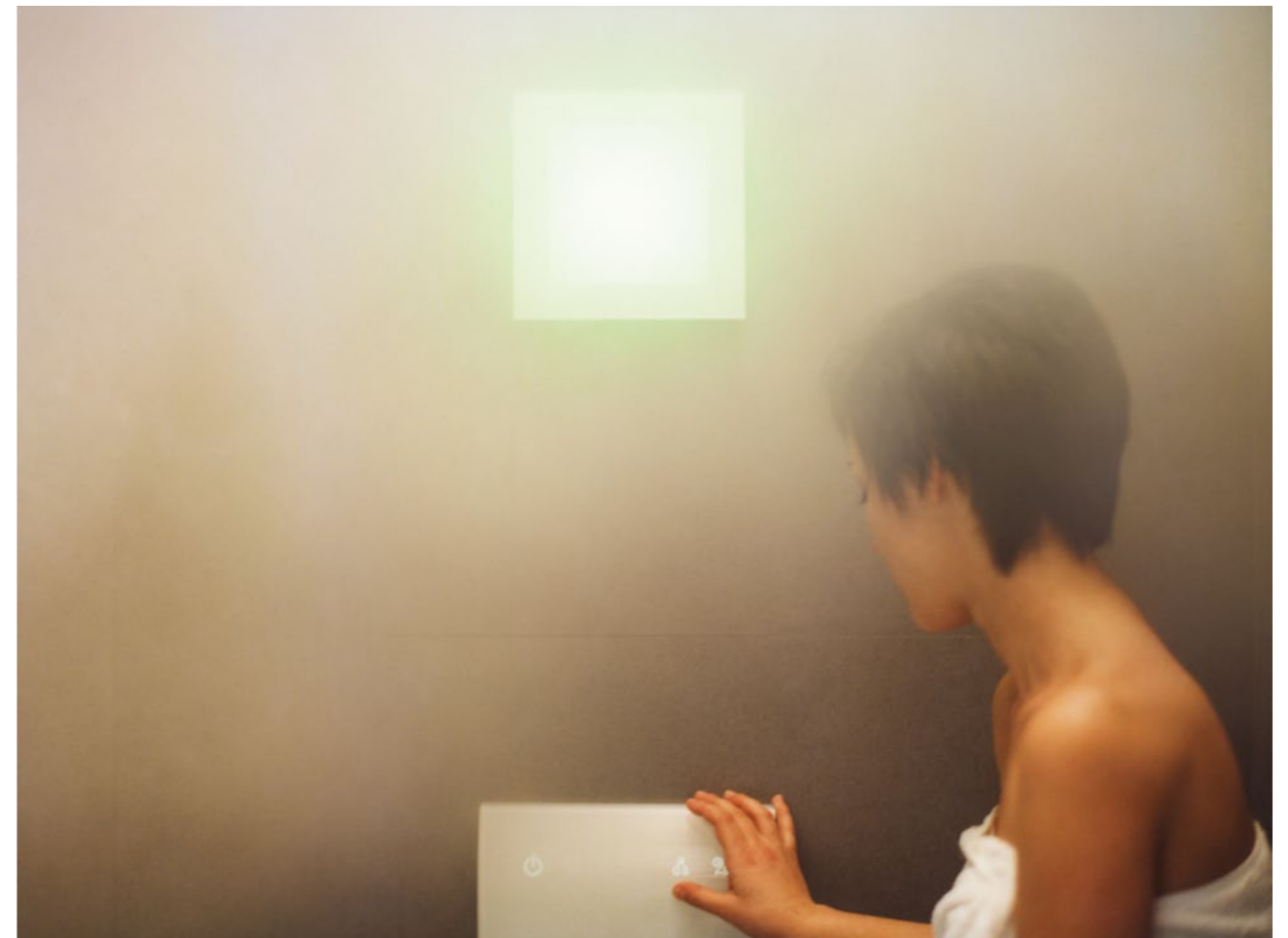

1

Easystem:
steam generator with
aroma therapy

Easystem:
generatore di vapore
con aromaterapia

2

Effe steam generation
technology gives you
maximum control over
hygiene, lime-scale build-up
and steam quality

Tecnologia Effe per la
generazione del vapore:
igiene, controllo del calcare e
massima qualità del vapore

3

Low maintenance and a long
life thanks to the automatic
boiler-cleaning system

Manutenzione ridotta e lunga
durata grazie al sistema
automatico di lavaggio della
caldaia

4

Extremely compact design
featuring a curved panel of
silk-screen-printed glass,
visible thickness 3.7cm

Design molto compatto
costituito da una lastra di
vetro curvato serigrafato,
spessore visibile: 3,7 cm

5

PSF (Power Steam Function):
the innovative ventilation
management system
minimises temperature
layering

PSF (Power Steam
Function): innovativo
sistema di ventilazione che
minimizza la stratificazione
delle temperature

6

Touch-screen control panel
with backlit icons and
temperature indicator

Pannello di controllo touch
con icone retroilluminate
e indicatore del livello di
temperatura

7

Set up for connection
to a white or chromotherapy
light fitting

Predisposizione per
collegamento a lampada con
luce bianca o cromoterapia

8

The ECC (Effe Comfort
Control) function enables
the Turkish bath to be
managed remotely
from a tablet or smartphone

Funzione ECC
(Effe Comfort Control):
il sistema consente di gestire
a distanza il bagno turco
da tablet o smartphone

DIMENSIONS
CM 25 X 3,7 X 57 H

COUNTERBOX DIMENSIONS
CM 42 X 11 X 64 H
WITH SCHLÜTER WATERPROOFING
MAT

MATERIALS
• CURVED SILK-SCREEN PRINTED
GLASS PANEL;
• PAINTED ALUMINIUM RAL 9003.

FEATURES
• BUILT IN STEAM GENERATOR;
• AUTOMATIC BOILER CLEANING
SYSTEM;
• WATER FLOW RATE CONTROL SYSTEM;
• AUTOMATIC WATER DRAINAGE
SYSTEM;
• AUTOMATIC ENERGY SAVER
FUNCTION;
• TOUCH-SCREEN CONTROL
PANEL WITH BACKLIT ICONS AND
TEMPERATURE GAUGE;
• CONTAINERS FOR ESSENTIAL OILS.

ECC - EFFE COMFORT CONTROL
THIS SYSTEM IS BUILT INTO
THE EFFE STEAM GENERATOR,
ENABLING REMOTE CONTROL OF
THE TURKISH BATH FROM A TABLET
OR SMARTPHONE USING THE EFFE
EXPERIENCE APP.

MODEL	VOLUME (M ³)	POWER (KW)
30	0 - 3,5	3,0
45	3,5 - 4,5	4,5

DIMENSIONI
CM 25 X 3,7 X 57 H

DIMENSIONI CONTROCASSA
CM 42 X 11 X 64 H
COMPLETA DI TESSUTO
IMPERMEABILIZZANTE SCHLÜTERH
MAT

MATERIALI
• VETRO CURVATO SERIGRAFATO;
• ALLUMINIO VERNICIATO RAL 9003.

CARATTERISTICHE
• GENERATORE DI VAPORE INTERNO;
• SISTEMA AUTOMATICO DI LAVAGGIO
CALDAIA;
• SISTEMA DI REGOLAZIONE PORTATA
ACQUA;
• SISTEMA AUTOMATICO DI SCARICO
ACQUA;
• FUNZIONE ENERGY SAVER
AUTOMATICA;
• PANNELLO DI CONTROLLO TOUCH
CON ICONE RETROILLUMINATE
E INDICATORE DEL LIVELLO DI
TEMPERATURA;
• CONTENITORI PER ESSENZE.

ECC - EFFE COMFORT CONTROL
IL SISTEMA È INTEGRATO NEL
GENERATORE DI VAPORE EFFE E
CONSENTE DI GESTIRE A DISTANZA
IL BAGNO TURCO TRAMITE APP
"EFFE EXPERIENCE" SU TABLET O
SMARTPHONE.

MODELLO	CUBATURA (M ³)	POTENZA (KW)
30	0 - 3,5	3,0
45	3,5 - 4,5	4,5

EASYSTEAM SMART

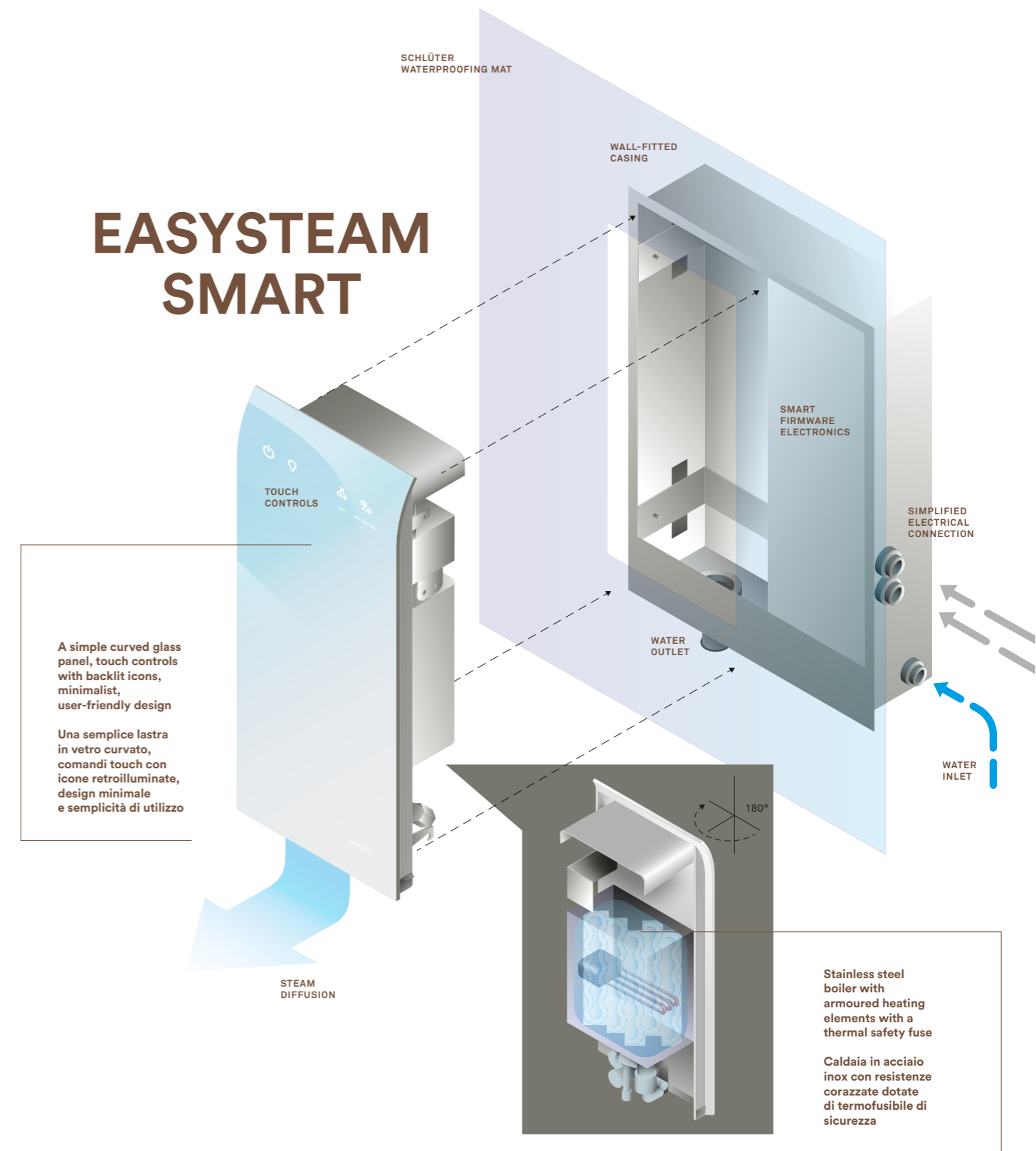

A simple curved glass
panel, touch controls
with backlit icons,
minimalist,
user-friendly design

Una semplice lastra
in vetro curvato,
comandi touch con
icone retroilluminate,
design minimale
e semplicità di utilizzo

Stainless steel
boiler with
armoured heating
elements with a
thermal safety fuse

Caldaia in acciaio
inox con resistenze
corazzate dotate
di termofusibile di
sicurezza



[www.effe.it/en/product/
easystem-smart/
#video](http://www.effe.it/en/product/easystem-smart/#video)



[www.effe.it/prodotto/
easystem-smart/
#video](http://www.effe.it/prodotto/easystem-smart/#video)



AQUASTEAM SMART

A curved glass panel with digital controls, a spring and a bowl make Aquasteam an intuitive steam generator to use that blends perfectly with any décor

Una lastra di vetro curvato con comandi digitali, una fonte e una ciotola rendono Aquasteam un generatore di vapore intuitivo nell'uso e perfettamente abbinabile a qualsiasi rivestimento



PSF
POWER
STEAM
FUNCTION



SEC
SMART
ENERGY
CONTROL



SBC
SMART
BOILER
CLEANING



SWF
SMART
WATER
FILLING



RWF
REGULATING
WATER
FLOW



ECC
EFFE
COMFORT
CONTROL



ODS
OPEN
DOOR
SENSOR

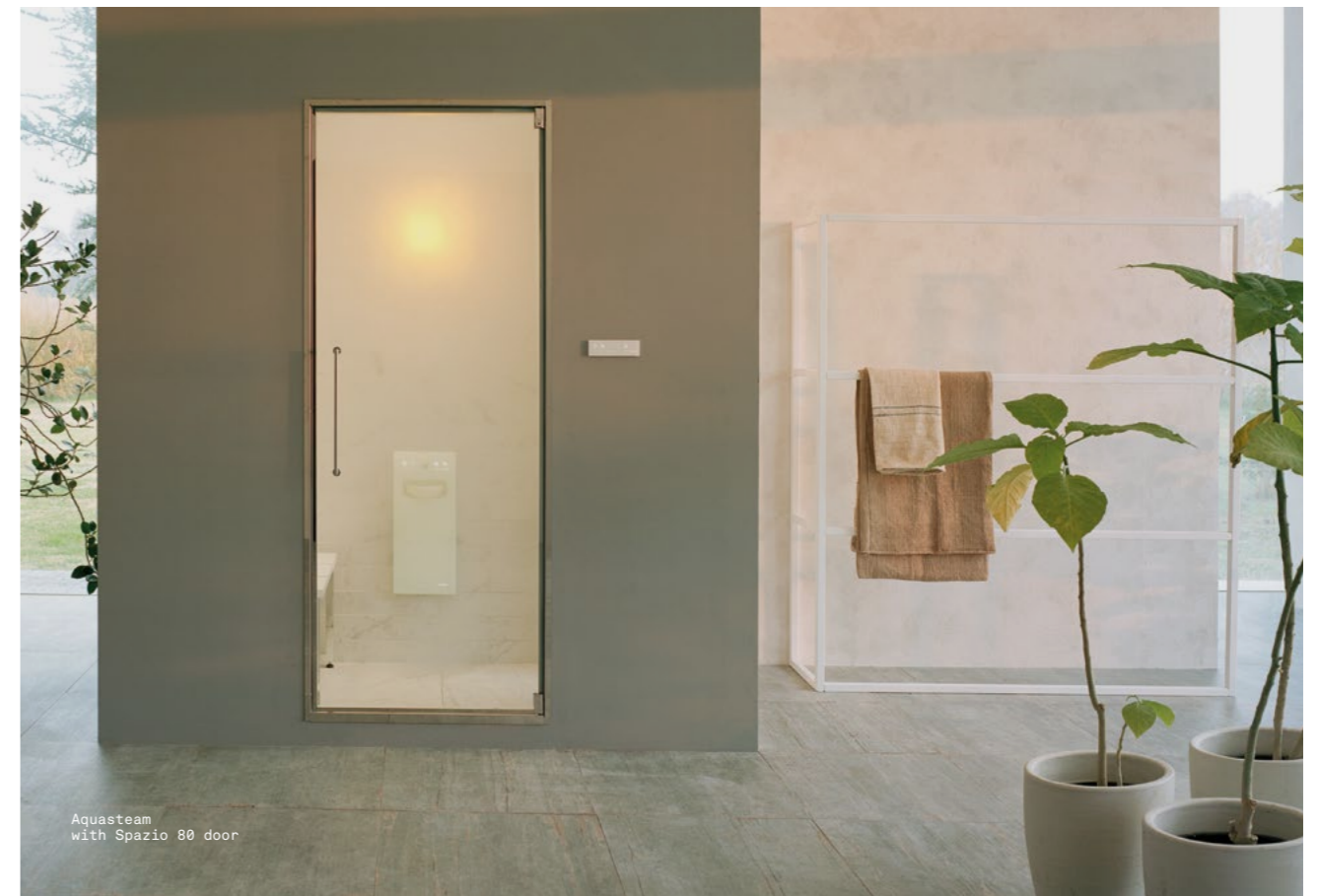

Aquasteam
with Spazio 80 door

1

Aquasteam:
steam generator with
spring, bowl and aroma
therapy

Aquasteam:
generatore di vapore
con fonte, ciotola,
aromaterapia

2

Effe steam generation
technology gives you
maximum control over
hygiene, lime-scale build-up
and steam quality

Tecnologia Effe per la
generazione del vapore:
igiene, controllo del calcare
e massima qualità del vapore

3

Low maintenance and a long
life thanks to the automatic
boiler-cleaning system

Manutenzione ridotta e lunga
durata grazie al sistema
automatico di lavaggio della
caldaia

4

Extremely compact design
featuring a curved panel
of silk-screen-printed glass,
visible thickness 3.7cm

Design molto compatto
costituito da una lastra
di vetro curvato serigrafato,
spessore visibile: 3,7 cm

5

PSF (Power Steam Function):
the innovative ventilation
management system
minimises temperature
layering

PSF (Power Steam
Function): innovativo
sistema di ventilazione
che minimizza la stratificazione
delle temperature

6

Touch-screen control panel
with backlit icons and
temperature indicator

Pannello di controllo touch
con icone retroilluminate
e indicatore del livello
di temperatura

7

Set up for connection
to a white or chromotherapy
light fitting

Predisposizione per
collegamento a lampada con
luce bianca o cromoterapia

8

The ECC (Effe Comfort
Control) function enables
the Turkish bath to be
managed remotely
from a tablet or smartphone

Funzione ECC
(Effe Comfort Control):
il sistema consente di gestire
a distanza il bagno turco
da tablet o smartphone

DIMENSIONS

CM 25 X 3,7 X 57 H

COUNTERBOX DIMENSIONS

CM 42 X 11 X 64 H
WITH SCHLÜTER WATERPROOFING
MAT

MATERIALS

- CURVED SILK-SCREEN PRINTED GLASS PANEL;
- PAINTED ALUMINIUM RAL 9003.

FEATURES

- BUILT IN STEAM GENERATOR;
- AUTOMATIC BOILER CLEANING SYSTEM;
- WATER FLOW RATE CONTROL SYSTEM;
- AUTOMATIC WATER DRAINAGE SYSTEM;
- AUTOMATIC ENERGY SAVER FUNCTION;
- TOUCH-SCREEN CONTROL PANEL WITH BACKLIT ICONS AND TEMPERATURE GAUGE;
- WATERFALL SPRING WITH CONTROLLED BACKLIT WATER FLOW;
- BOWL IN WHITE RESIN;
- CONTAINERS FOR ESSENTIAL OILS.

ECC - EFFE COMFORT CONTROL

THIS SYSTEM IS BUILT INTO THE EFFE STEAM GENERATOR, ENABLING REMOTE CONTROL OF THE TURKISH BATH FROM A TABLET OR SMARTPHONE USING THE EFFE EXPERIENCE APP.

MODEL	VOLUME (M ³)	POWER (KW)
30	0 - 3,5	3,0
45	3,5 - 4,5	4,5

DIMENSIONI

CM 25 X 3,7 X 57 H

DIMENSIONI CONTROCCASSA

CM 42 X 11 X 64 H
COMPLETA DI TESSUTO
IMPERMEABILIZZANTE SCHLÜTER

MATERIALI

- VETRO CURVATO SERIGRAFATO;
- ALLUMINIO VERNICIATO RAL 9003.

CARATTERISTICHE

- GENERATORE DI VAPORE INTERNO;
- SISTEMA AUTOMATICO DI LAVAGGIO CALDAIA;
- SISTEMA DI REGOLAZIONE PORTATA ACQUA;
- SISTEMA AUTOMATICO DI SCARICO ACQUA;
- FUNZIONE ENERGY SAVER AUTOMATICA;
- PANNELLO DI CONTROLLO TOUCH CON ICONE RETROILLUMINATE E INDICATORE DEL LIVELLO DI TEMPERATURA;
- FONTE A CADUTA CON EROGAZIONE ACQUA CONTROLLATA E RETROILLUMINATA;
- CIOTOLA IN RESINA BIANCA;
- CONTENITORI PER ESSENZE.

ECC - EFFE COMFORT CONTROL

IL SISTEMA È INTEGRATO NEL GENERATORE DI VAPORE EFFE E CONSENTE DI GESTIRE A DISTANZA IL BAGNO TURCO TRAMITE APP "EFFE EXPERIENCE" SU TABLET O SMARTPHONE.

MODELLO	CUBATURA (M ³)	POTENZA (KW)
30	0 - 3,5	3,0
45	3,5 - 4,5	4,5

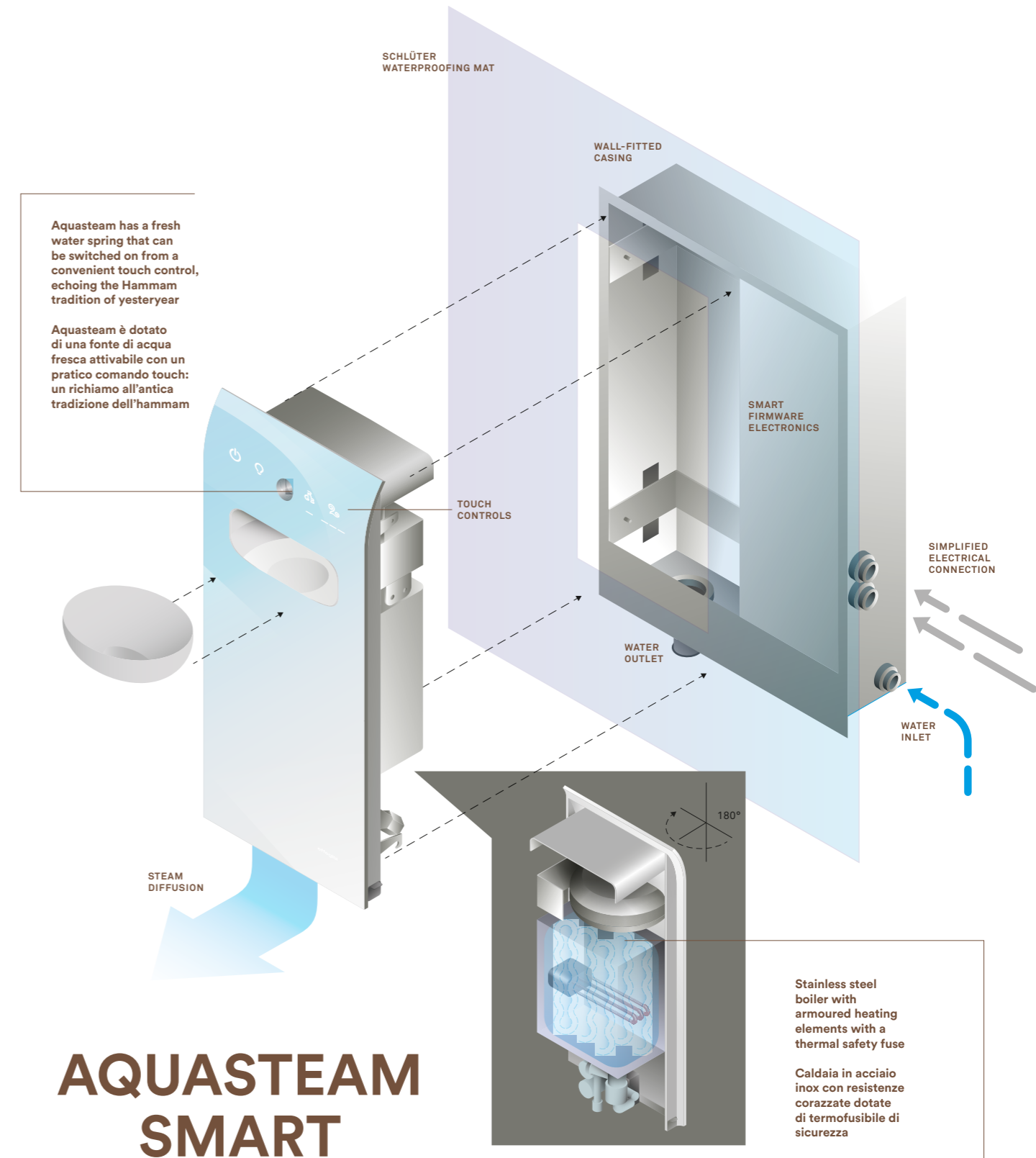

www.effe.it/en/product/aquasteam-smart/#video



www.effe.it/prodotto/aquasteam-smart/#video

TOUCH&STEAM

Touch&steam is a stylish, lightweight professional-standard generator that can be fitted to any shower or Hammam environment. State-of-the-art steam-generating technology

Inseribile in ogni doccia o ambiente hammam, Touch&steam è un generatore professionale dal design elegante e leggero. Il massimo della tecnologia nella produzione di vapore



PSF
POWER
STEAM
FUNCTION



SEC
SMART
ENERGY
CONTROL



SBC
SMART
BOILER
CLEANING



SWF
SMART
WATER
FILLING



RWF
REGULATING
WATER
FLOW



ECC
EFFE
COMFORT
CONTROL



ODS
OPEN
DOOR
SENSOR



ESS
EFFE
SOUND
SYSTEM



1

Touch&Steam: steam generator with colour and aroma therapy

Touch&Steam: generatore di vapore con cromoterapia e aromaterapia

2

Touch-screen control panel with backlit icons and temperature indicator

Pannello di controllo touch con icone retroilluminate e indicatore del livello di temperatura

3

Effe steam generation technology gives you maximum control over steam quality, density and hygiene

Tecnologia Effe per la generazione del vapore: il massimo del controllo su qualità, densità e igiene

4

Warm air function: forced ventilation heating system with unit pre-heating function

Caldo Doccia: sistema di riscaldamento a ventilazione forzata con funzione di preriscaldamento vano

5

Low maintenance thanks to the automatic boiler-cleaning system that minimises lime-scale build-up

Manutenzione ridotta grazie al sistema automatico di lavaggio della caldaia che minimizza l'accumulo di calcare

6

Stylish, compact design featuring a panel of silk-screen-printed toughened glass, visible thickness 3.7cm

Design elegante e compatto costituito da una lastra di vetro temperato serigrafato, spessore visibile: 3,7 cm

7

PSF (Power Steam Function): the innovative ventilation management system minimises temperature layering

PSF (Power Steam Function): innovativo sistema di ventilazione che minimizza la stratificazione delle temperature

8

The ECC (Effe Comfort Control) function enables the Turkish bath to be managed remotely from a tablet or smartphone

Funzione ECC (Effe Comfort Control): il sistema consente di gestire a distanza il bagno turco da tablet o smartphone

9

ESS (Effe Sound System) delivers music from your own device

ESS (Effe Sound System) per il controllo della musica direttamente dal proprio dispositivo

DIMENSIONS
CM 23 X 3,7 X 165 H

COUNTERBOX DIMENSIONS
CM 40 X 10 X 173 H
WITH SCHLÜTER WATERPROOFING MAT

MATERIALS

- SCREEN-PRINTED TEMPERED GLASS PANEL;
- PAINTED ALUMINIUM RAL 9003.

FEATURES

- BUILT IN STEAM GENERATOR;
- AUTOMATIC BOILER CLEANING SYSTEM;
- WATER FLOW RATE CONTROL SYSTEM;
- AUTOMATIC WATER DRAINAGE SYSTEM;
- AUTOMATIC ENERGY SAVER FUNCTION;
- TOUCH-SCREEN CONTROL PANEL WITH BACKLIT ICONS AND TEMPERATURE GAUGE;
- POWER STEAM FUNCTION: STEAM DIFFUSION AND FORCED VENTILATION HEATING SYSTEM;
- CALDO DOCCIA FUNCTION: UNIT PRE-HEATING FUNCTION WITH FORCED VENTILATION HEATING SYSTEM;
- CONTAINERS FOR ESSENTIAL OILS;
- LIGHTING SYSTEM WITH LED RGB CHROMOTHERAPY 5 FIXED COLOURS, 4 DYNAMIC CYCLES AND WHITE LIGHT.
- ESS (EFFE SOUND SYSTEM) DELIVERS MUSIC FROM YOUR OWN DEVICE.

ECC - EFFE COMFORT CONTROL
THIS SYSTEM IS BUILT INTO THE EFFE STEAM GENERATOR, ENABLING REMOTE CONTROL OF THE TURKISH BATH FROM A TABLET OR SMARTPHONE USING THE EFFE EXPERIENCE APP.

MODEL	VOLUME (M ³)	POWER (KW)
30	0 - 3,5	3,0
45	3,5 - 4,5	4,5
60	4,5 - 6,2	6,0
90	6,2 - 9,2	9,0

DIMENSIONI
CM 23 X 3,7 X 165 H

DIMENSIONI CONTROCASSA
CM 40 X 10 X 173 H
COMPLETA DI TESSUTO IMPERMEABILIZZANTE SCHLÜTER

MATERIALI

- VETRO TEMPERATO SERIGRAFATO;
- ALLUMINIO VERNICIATO RAL 9003.

CARATTERISTICHE

- GENERATORE DI VAPORE INTERNO;
- SISTEMA AUTOMATICO DI LAVAGGIO CALDAIA;
- SISTEMA DI REGOLAZIONE PORTATA ACQUA;
- SISTEMA AUTOMATICO DI SCARICO ACQUA;
- FUNZIONE ENERGY SAVER AUTOMATICA;
- PANNELLO DI CONTROLLO TOUCH CON ICONE RETROILLUMINATE E INDICATORE DEL LIVELLO DI TEMPERATURA;
- FUNZIONE POWER STEAM: SISTEMA DI DIFFUSIONE VAPORE A VENTILAZIONE FORZATA;
- FUNZIONE CALDO DOCCIA: SISTEMA DI RISCALDAMENTO A VENTILAZIONE FORZATA CON FUNZIONE PRERISCALDAMENTO;
- VANO CONTENITORI PER ESSENZE;
- ILLUMINAZIONE CON CROMOTERAPIA A LED RGB, 5 COLORI FISSI, 4 CICLI DINAMICI E LUCE BIANCA.
- ESS (EFFE SOUND SYSTEM): CONTROLLO DELLA MUSICA DAL PROPRIO DISPOSITIVO.

ECC - EFFE COMFORT CONTROL
IL SISTEMA È INTEGRATO NEL GENERATORE DI VAPORE EFFE E CONSENTE DI GESTIRE A DISTANZA IL BAGNO TURCO TRAMITE APP "EFFE EXPERIENCE" SU TABLET O SMARTPHONE.

MODELLO	CUBATURA (M ³)	POTENZA (KW)
30	0 - 3,5	3,0
45	3,5 - 4,5	4,5
60	4,5 - 6,2	6,0
90	6,2 - 9,2	9,0

TOUCH&STEAM

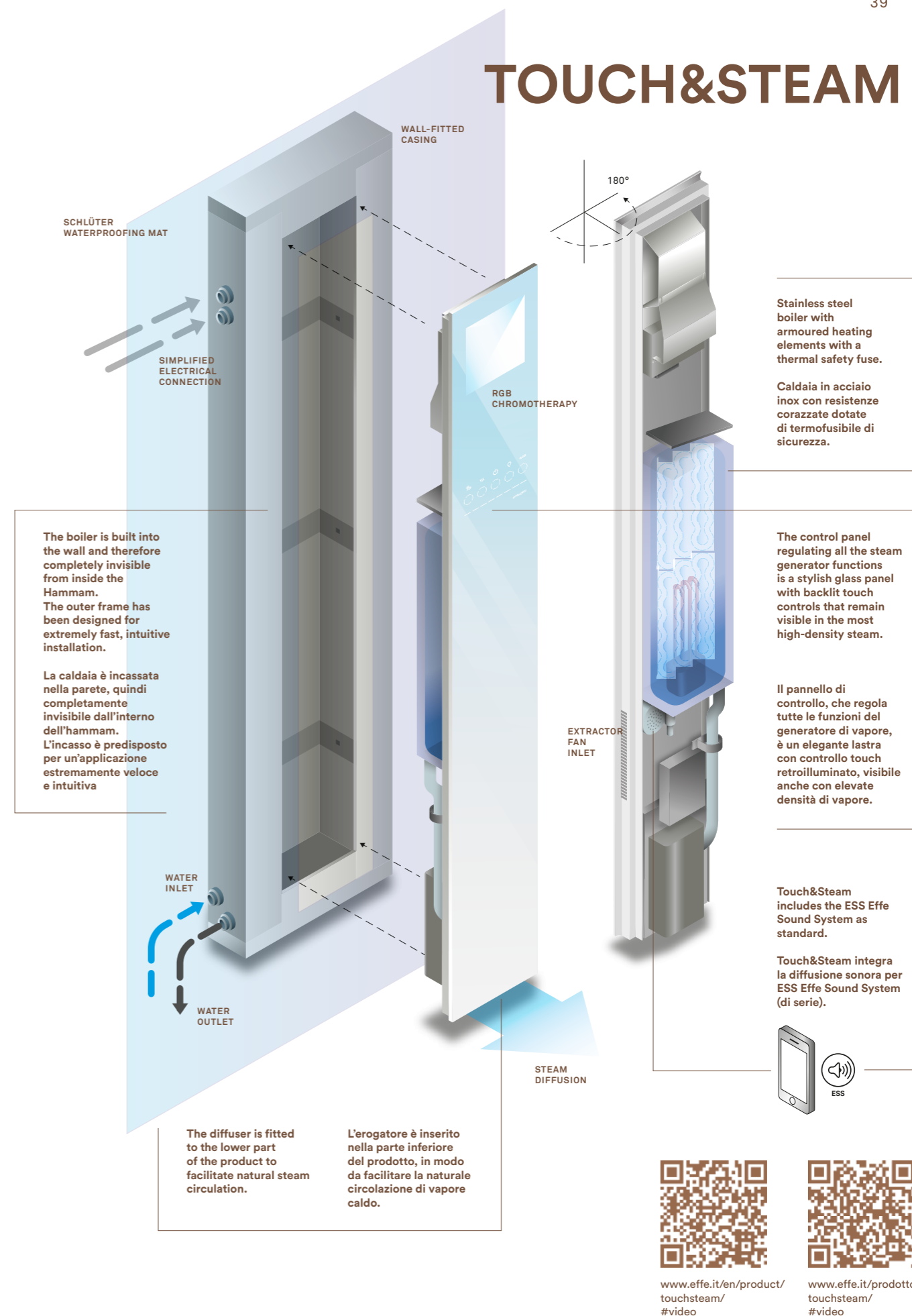



Touch&Steam steam generator with Spaziofilo door

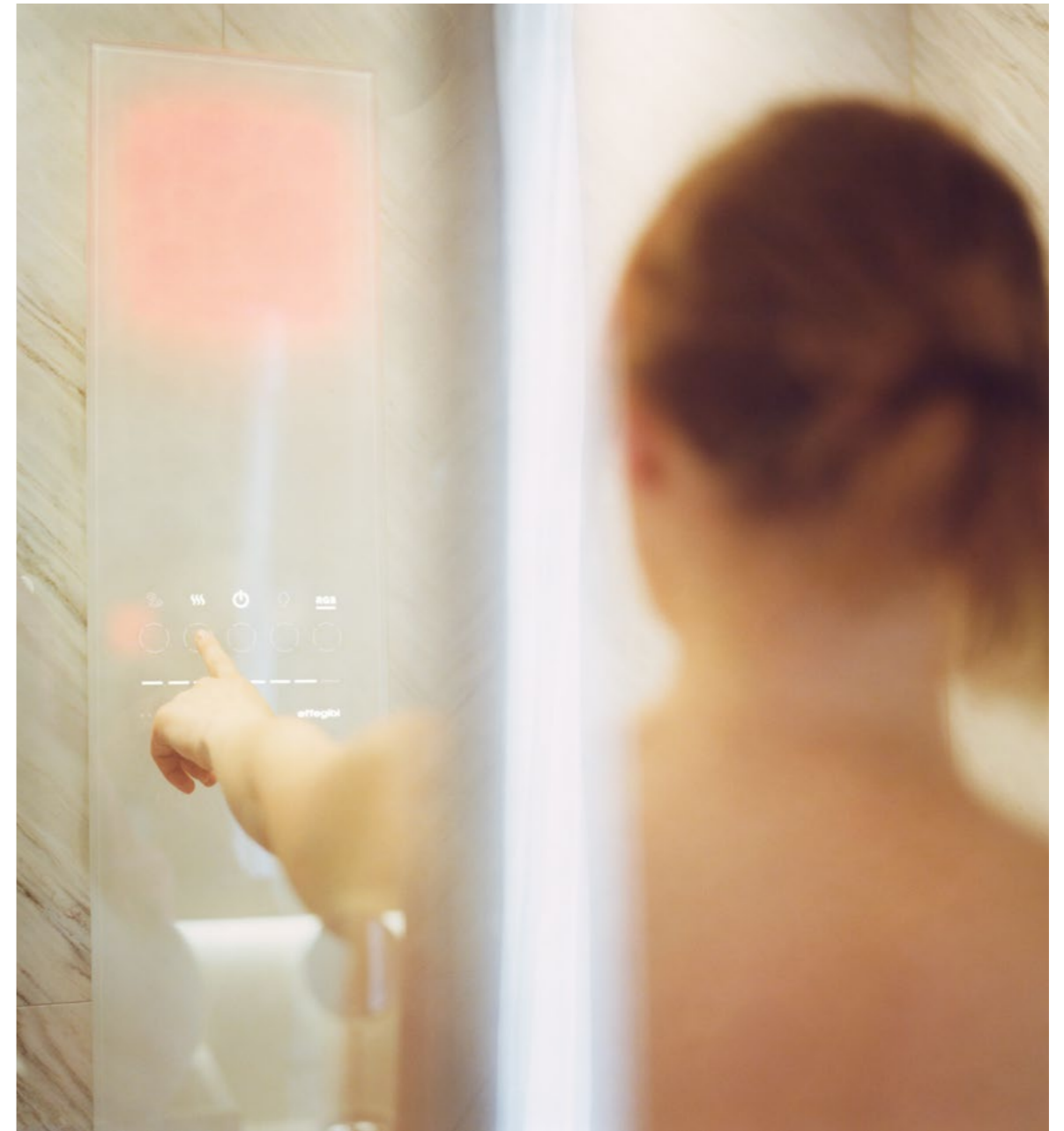

Touch&Steam: RGB Chromotherapy lamp and glass panel with backlit touch controls

DOORS AND GLASS PANELS

PORTE E VETRATE

The special doors created by Effe for Hammams are designed to ensure a perfect seal against the escape of steam thus ensuring proper air circulation.

Stainless steel and 8mm-thick toughened glass make each model tough and long-lasting and easily adaptable to any furnishing style. Effe's special doors also enable any ordinary home shower to be transformed into the perfect Turkish bath.

Le speciali porte Effe per hammam sono progettate per ottenere una tenuta perfetta alla fuoriuscita del vapore, garantendo il giusto ricircolo d'aria.

L'acciaio inox, l'alluminio e il vetro temperato di 8 mm di spessore rendono ogni modello molto durevole e facilmente abbinabile allo stile di ogni arredamento. Grazie alle porte Effe, anche la semplice doccia di casa può essere trasformata in un perfetto bagno turco.

FITBOX

Fitbox A 120x80
Fitbox A 140x90
Fitbox B 120x80
Fitbox B 140x90

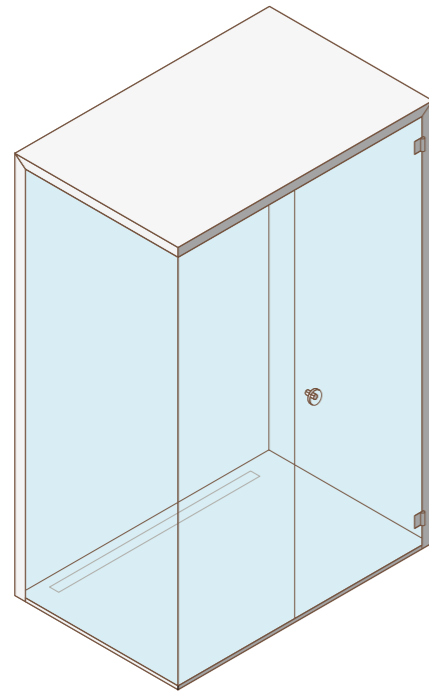

FIT

Fit 65
Fit 80
Fit 50 Glass Panel
Fit A 120
Fit B 120

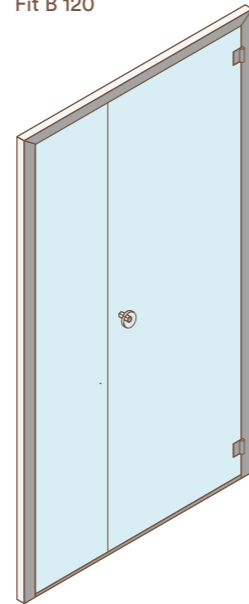

COUNTERFRAME
CONTROTELAIO

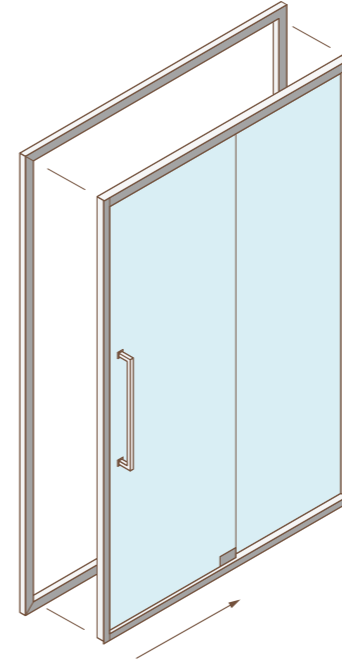

SPAZIOSLIDE

Spazioslide 130
Spazioslide 160

SPAZIO

Spazio 80
Spazio 120
Spazio 160
Spazio 40 Glass Panel
Spazio 80 Glass Panel

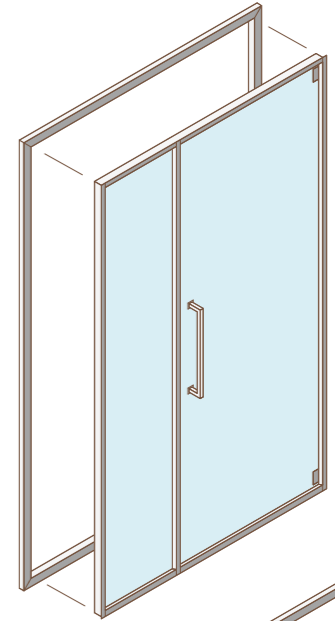

SPAZIOFILO

Spaziofilo 80
Spaziofilo 100
Spaziofilo 120
Spaziofilo 160
Spaziofilo 40 Glass Panel
Spaziofilo 80 Glass Panel

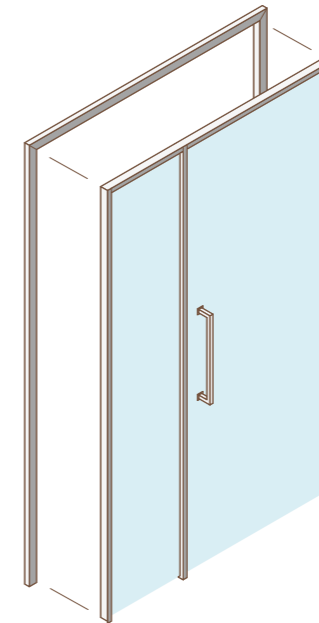

TUTTOVETRO CONTOUR

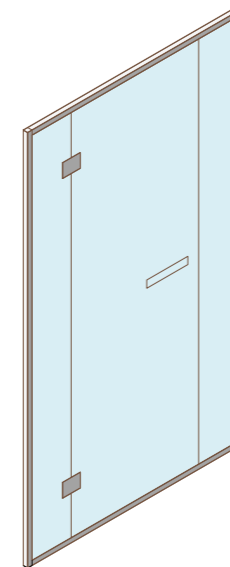

TUTTOVETRO INSIDE

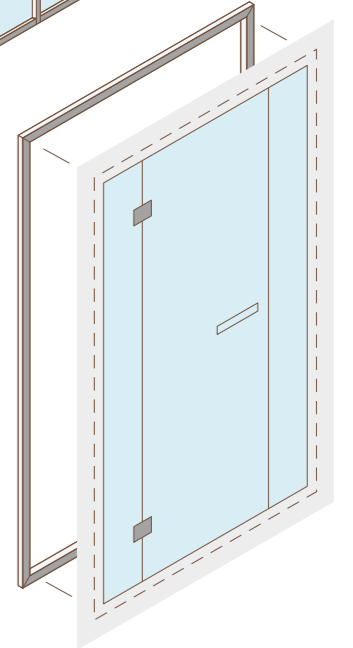



FITBOX

MATERIALS

- › Aluminium frame
- › Transparent 8 mm toughened glass
- › Ceiling in satin-finish 3+3mm layered glass

MATERIALI

- › Telaio in alluminio
- › Vetro temperato trasparente 8mm
- › Tetto in vetro stratificato satinato 3+3 mm

FINISH

- › Brushed aluminium finish edges
- › Black edges in aluminium with a brushed black anodised finish

FINITURE DISPONIBILI

- › Profili in alluminio finitura spazzolato
- › Profili in alluminio finitura anodizzato nero opaco

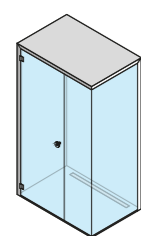

FITBOX A 120 X 80
H 210 CM

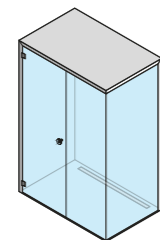

FITBOX A 140 X 90
H 210 CM

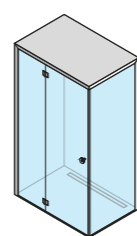

FITBOX B 120 X 80
H 210 CM

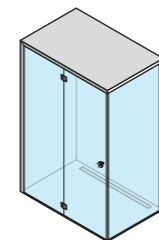

FITBOX B 140 X 90
H 210 CM



FIT

MATERIALS

- › Brushed aluminium finish edges (brushed aluminium, anodised black)
- › Transparent 8 mm toughened glass

MATERIALI

- › Telaio in alluminio finitura spazzolato (alluminio spazzolato, nero anodizzato)
- › Vetro temperato trasparente 8 mm

FEATURES

- › Classic pull-open door
- › Flush with the flooring
- › Right or left-opening options
- › Lower ventilation

CARATTERISTICHE

- › Porta con apertura classica
- › A filo pavimento
- › Disponibile in versione destra o sinistra
- › Aerazione inferiore



FIT 65
L 65 CM
H 190 CM



FIT 80
L 80 CM
H 210 CM



**FIT 50
GLASS PANEL**
L 50 CM
H 210 CM



FIT A 120
L 120 CM
H 210 CM



FIT B 120
L 120 CM
H 210 CM



Touch&Steam steam generator
with Spazioslide door



SPAZIOSLIDE

MATERIALS

- › Aluminium frame
- › Cover in Shiny stainless steel
- › Shiny stainless steel handle
- › Transparent 8 mm toughened glass

MATERIALI

- › Telaio in alluminio
- › Cover in acciaio inox lucido
- › Maniglia in acciaio inox lucido
- › Vetro temperato trasparente 8 mm

FEATURES

- › Sliding version
- › Right or left-opening options
- › Fitted to counterframe
- › Lower ventilation

CARATTERISTICHE

- › Apertura scorrevole
- › Disponibile in versione destra o sinistra
- › Montaggio su controtelaio
- › Aerazione inferiore

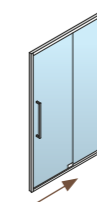

SPAZIOSLIDE 130
L 130 CM
H 200 CM



SPAZIOSLIDE 160
L 160 CM
H 200 CM



SPAZIO

MATERIALS

- › Aluminium frame
- › Cover in shiny stainless steel
- › Shiny stainless steel handle
- › Transparent 8 mm toughened glass

MATERIALI

- › Telaio in alluminio
- › Cover in acciaio inox lucido
- › Maniglia in acciaio inox lucido
- › Vetro temperato trasparente 8 mm

FEATURES

- › Classic pull-open door
- › Reversibile
- › Fitted to counterframe
- › Lower ventilation

CARATTERISTICHE

- › Porta con apertura classica
- › Reversibile
- › Montaggio su controtelaio
- › Aerazione inferiore

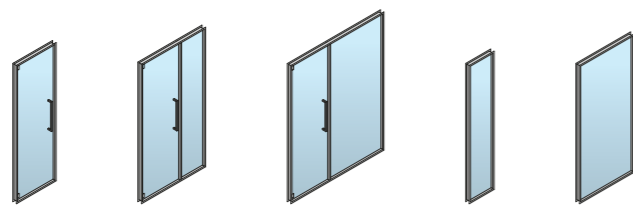

SPAZIO 80
L 80 CM
H 200 CM

SPAZIO 120
L 120 CM
H 200 CM

SPAZIO 160
L 160 CM
H 200 CM

**SPAZIO 40
GLASS PANEL**
L 43 CM
H 200 CM

**SPAZIO 80
GLASS PANEL**
L 83 CM
H 200 CM



SPAZIOFILO

MATERIALS

- › Aluminium frame
- › Cover in shiny stainless steel
- › Shiny stainless steel handle
- › Transparent 8 mm toughened glass

MATERIALI

- › Telaio in alluminio
- › Cover in acciaio inox lucido
- › Maniglia in acciaio inox lucido
- › Vetro temperato trasparente 8 mm

FEATURES

- › Classic pull-open door
- › Flush with the flooring
- › Right or left-opening options
- › Fitted to counterframe
- › Lower ventilation

CARATTERISTICHE

- › Porta con apertura classica
- › A filo pavimento
- › Disponibile in versione destra o sinistra
- › Montaggio su controtelaio
- › Aerazione inferiore



SPAZIOFILO 80
L 80 CM
H 198,3 CM

SPAZIOFILO 100
L 100 CM
H 198,3 CM

SPAZIOFILO 120
L 120 CM
H 198,3 CM

SPAZIOFILO 160
L 160 CM
H 198,3 CM

**SPAZIOFILO 40
GLASS PANEL**
L 43 CM
H 198,3 CM

**SPAZIOFILO 80
GLASS PANEL**
L 83 CM
H 198,3 CM



TUTTOVETRO CONTOUR

MATERIALS

- › Brushed aluminium
- › Aluminium with a shiny finishing
- › Brushed black anodised finish

MATERIALI

- › Alluminio spazzolato
- › Alluminio finitura brillantata
- › Finitura anodizzata nero opaco

FEATURES

- › Heights until 219 cm: transparent 8 mm toughened glass
- › Heights from 220 cm and over: glass thickness 10 mm

CARATTERISTICHE

- › Altezze fino a 219 cm: vetro temperato trasparente 8 mm
- › Altezze da 220 cm e oltre: spessore vetro 10 mm

MAXIMUM WIDTH 350 CM*
MAX HEIGHT 250 CM



MOD. A
DOOR



MOD. B
GLASS PANEL -
DOOR



MOD. C
GLASS PANEL -
DOOR -
GLASS PANEL

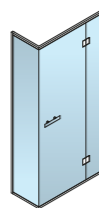

MOD. D
CORNER GLASS
PANEL -
DOOR

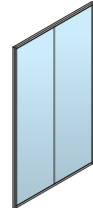

MOD. E
GLASS PANEL

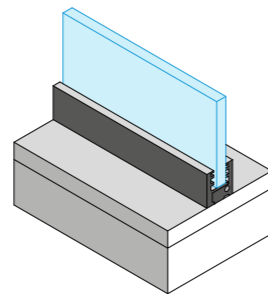

* FOR LARGER SIZES CONTACT EFFE



TUTTOVETRO INSIDE

MATERIALS

- › Edges in aluminium with a shiny finishing
- › Edges in brushed-finish aluminium
- › Edges in aluminium with a brushed black anodised finish

MATERIALI

- › profili in alluminio finitura brillantata
- › profili in alluminio finitura spazzolata
- › profili in alluminio finitura anodizzata nero opaco

FEATURES

- › Heights until 219 cm: transparent 8 mm toughened glass
- › Heights from 220 cm and over: glass thickness 10 mm

CARATTERISTICHE

- › Altezze fino a 219 cm: vetro temperato trasparente 8 mm
- › Altezze da 220 cm e oltre: spessore vetro 10 mm

MAX HEIGHT 250 CM

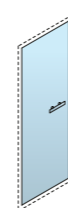

MOD. A
DOOR

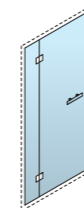

MOD. B
GLASS PANEL -
DOOR -

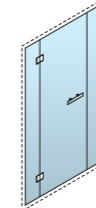

MOD. C
GLASS PANEL -
DOOR -
GLASS PANEL

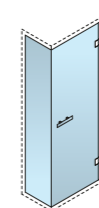

MOD. D
CORNER GLASS
PANEL -
DOOR

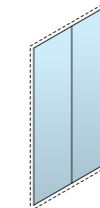

MOD. E
GLASS PANEL

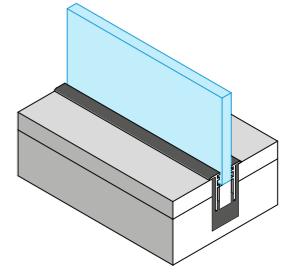

TRANSFORM YOUR SHOWER INTO A HAMMAM

TRASFORMA LA TUA DOCCIA IN HAMMAM

MEASURE YOUR AVAILABLE SPACE

MISURA LO SPAZIO CHE HAI A DISPOSIZIONE

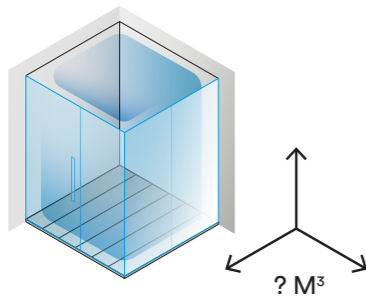

Any space can be transformed into a Hammam, just follow a few instructions for insulating walls and doors. It is very important to measure the volume that will play host to the Hammam so as to ensure the right steam generator is selected, based on its power.

Ogni vano può essere trasformato in hammam, basta seguire alcune indicazioni su come coibentare pareti e porte. Molto importante è definire i metri cubi destinati ad ospitare l'hammam perchè esistono differenti generatori di vapore che variano in base alla potenza.

CHOOSE THE RIGHT STEAM GENERATOR

SCEGLI IL GENERATORE DI VAPORE

Steam generators can be placed inside or outside the Hammam cubicle. You can base your choice on the available volume and also on your design preferences: Touch&Steam, Easystem and Aquasteam are stylish and easily adaptable to your own interior décor. They also have different functions that you can find out about in more detail on Page 56.

I generatori di vapore possono essere posizionati all'interno o all'esterno del vano hammam. Scegli in base ai metri cubi disponibili, oppure anche in base alle tue preferenze estetiche: Touch&Steam, Easystem e Aquasteam sono eleganti e adattabili facilmente allo stile del tuo arredo. Hanno anche funzioni differenti, che puoi scoprire nel dettaglio a pagina 56.

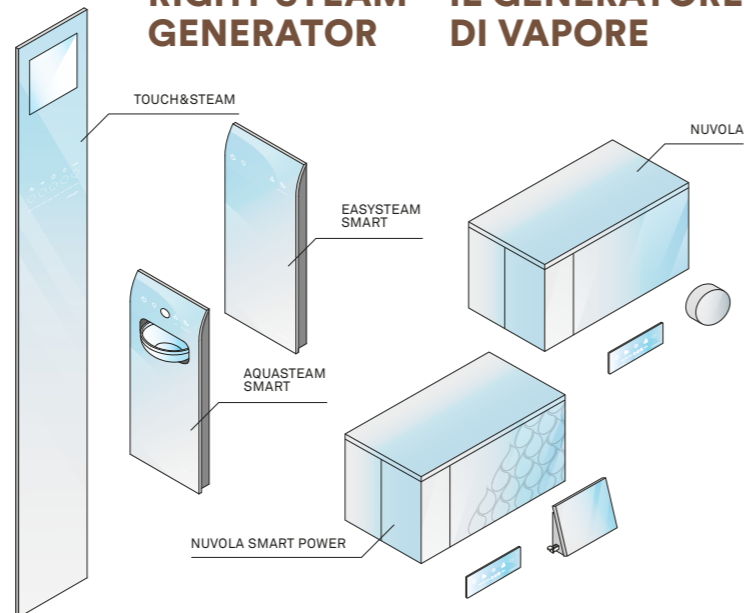

ADD THE INSULATION KIT AND CHOOSE AN EFFE HAMMAM DOOR

AGGIUNGI IL KIT COIBENTAZIONE E SCEGLI UNA PORTA EFFE PER HAMMAM

Proper cubicle insulation is recommended for the perfect Turkish bath. Effe doors provide an efficient steam seal and correct air inflow and exchange.

Per realizzare il bagno turco ideale è consigliata una perfetta coibentazione del vano. Le porte Effe garantiscono tenuta al vapore e un corretto ingresso e ricambio di aria.



www.effe.it/en/product/doors-and-glass-panels/



www.effe.it/prodotto/porte-e-vetrate

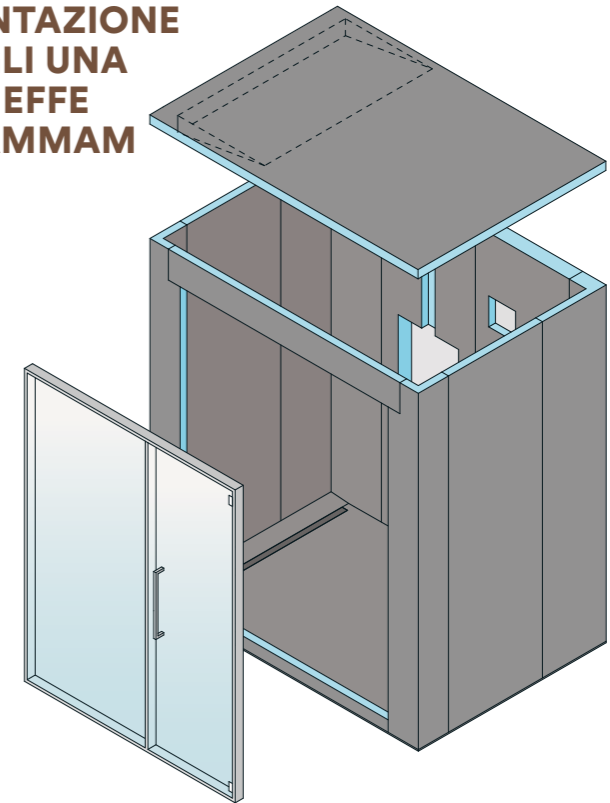

COMPLETE WITH FURNITURE AND ACCESSORIES

COMPLETA CON ARREDI E ACCESSORI

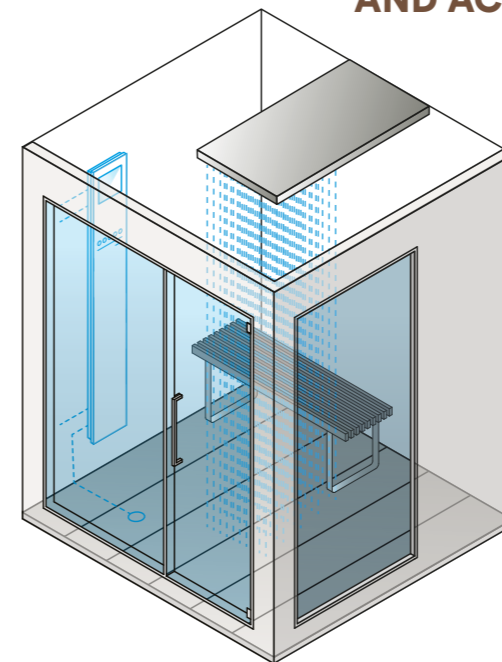

Effe makes it possible to personalise your shower-Hammam with a set of handy accessories: benches, seats, water springs, chromotherapy, the ESS Effe Sound System for listening to music inside the Hammam.

Effe permette di personalizzare la tua doccia-hammam con una serie di utili accessori: panche, sedute, fonti per acqua, cromoterapia, Effe Sound System per l'ascolto della musica all'interno.



www.effe.it/en/product/fittings-for-hammam/



www.effe.it/prodotto/arredi-per-hammam/



Touch&Steam
steam generator

UTILITY

HOW TO PREPARE THE HAMMAM SPACE TO INSTALL AN EFFE STEAM GENERATOR

COME PREDISPORRE IL VANO HAMMAM PER L'INSTALLAZIONE DI UN GENERATORE DI VAPORE EFFE

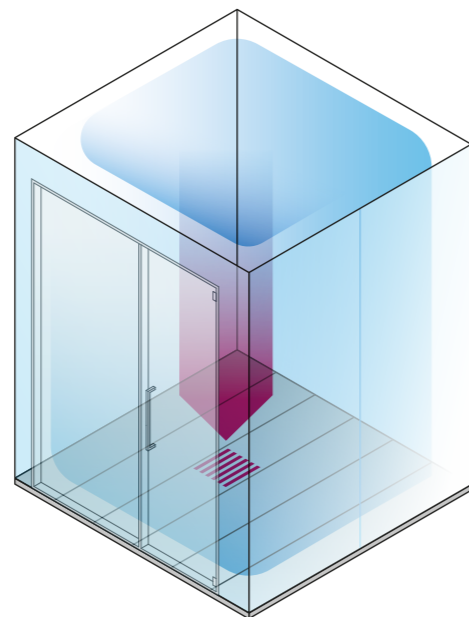

A water outlet must be installed in the floor of the Hammam, like in a regular shower.

Il vano hammam deve essere dotato di uno scarico acqua a pavimento, come quello di una normale doccia.

1
WATER OUTLET
IN THE FLOOR
SCARICO ACQUA
A PAVIMENTO

The Hammam cubicle must have a ceiling to prevent the steam escaping. A sloping ceiling reduces dripping from above.

Il vano hammam deve avere un soffitto, indispensabile per evitare la fuoriuscita del vapore. Un soffitto spiovente riduce il gocciolamento dall'alto.

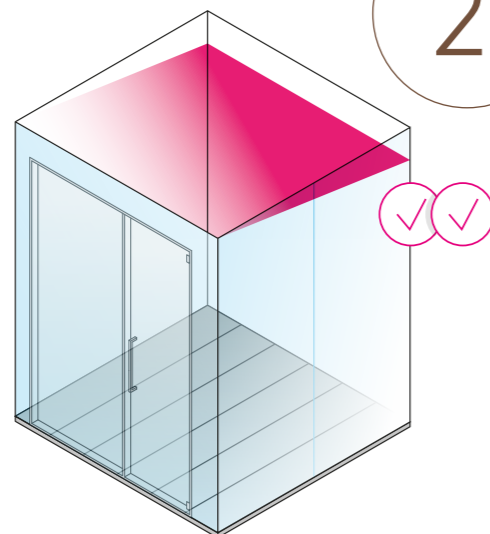
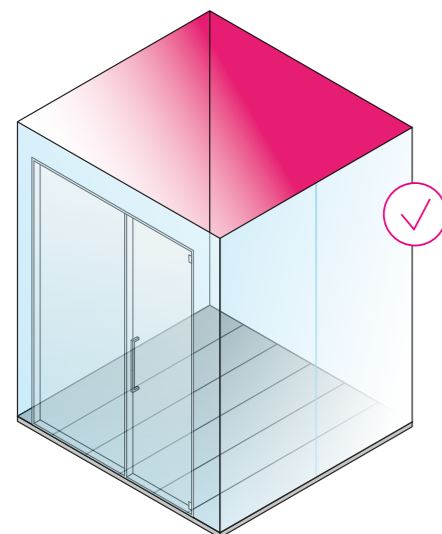

2
CLOSED CEILING
SOFFITTO CHIUSO

3
CONNECTIONS
PREDISPOSIZIONE IMPIANTI

The outlets for the electrics and plumbing must be prepared according to the steam generator and accessories chosen.

Le uscite delle reti elettrica e idrica vanno predisposti in base al generatore di vapore scelto e agli eventuali optional.

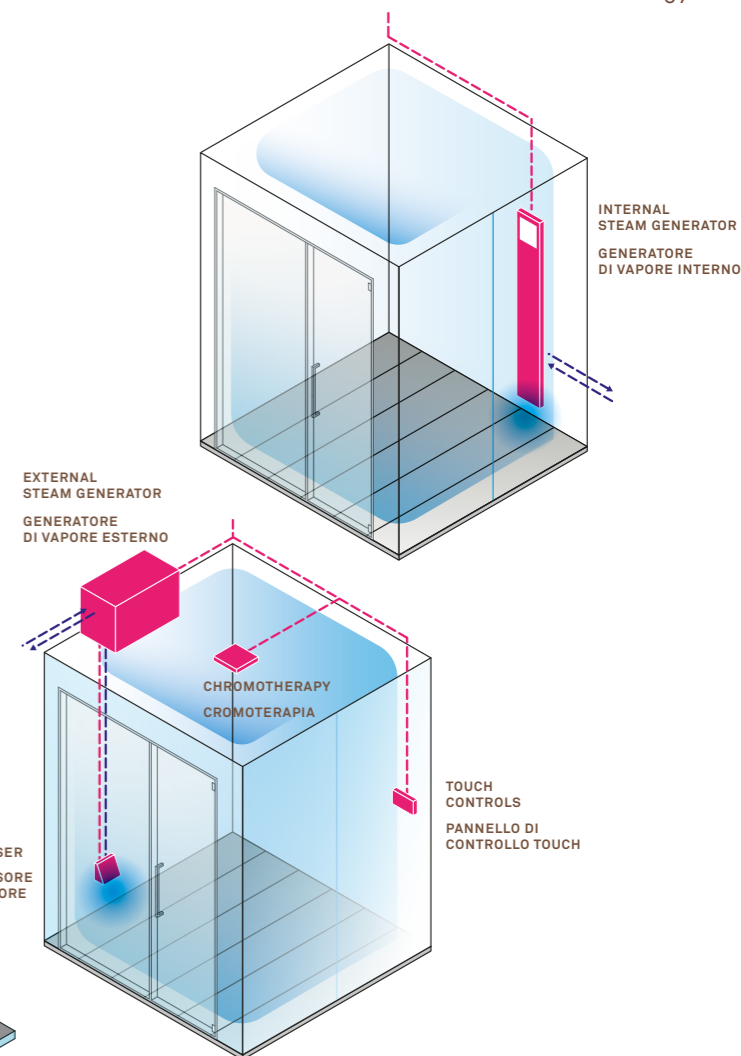

EXTERNAL STEAM GENERATOR
GENERATORE DI VAPORE ESTERNO

INTERNAL STEAM GENERATOR
GENERATORE DI VAPORE INTERNO

CHROMOTHERAPY
CROMOTERAPIA

STEAM DIFFUSER
DIFFUSORE DI VAPORE

TOUCH CONTROLS
PANNELLO DI CONTROLLO TOUCH

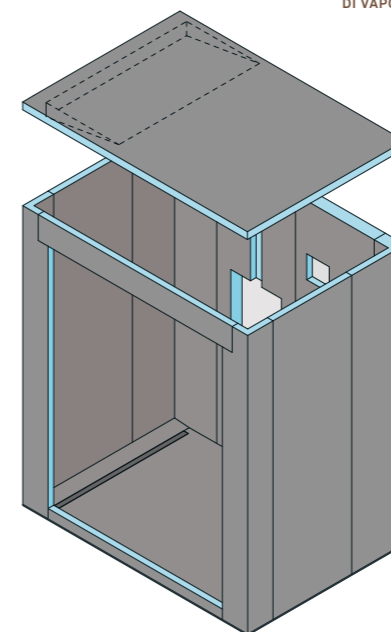

4
WALL INSULATION
COIBENTAZIONE PARETI

Just like a regular shower, the walls of the shower-Hammam must be insulated with a material that is at least 3 mm thick. Effe has designed a practical insulation kit specially for Hammams.

Come ogni normale doccia, anche la doccia-hammam dovrebbe avere pareti isolate con materiale di spessore di almeno 3 mm. Effe ha messo a punto un pratico Kit di coibentazione appositamente studiato per vani hammam.

5

**HAMMAM
DOOR**

**PORTA
PER HAMMAM**

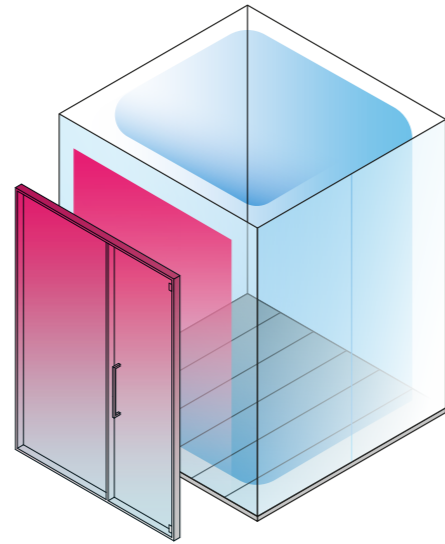

A special Hammam door must be fitted in the cubicle as this will ensure proper ventilation and air recirculation without altering the quality of the steam inside.

Il vano dovrebbe essere dotato di una porta specifica per hammam perché questa assicurerà la corretta ventilazione e il ricambio d'aria, senza compromettere la qualità del vapore interno.

**INTERNAL
STEAM GENERATOR**
GENERATORE
DI VAPORE INTERNO

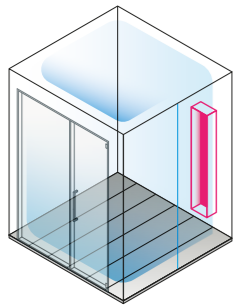

Depending on the type of steam generator chosen, a cavity must be prepared inside the Hammam for the:

- casing
- steam diffuser
- control panel
- colour therapy (if fitted)

**EXTERNAL
STEAM GENERATOR**
GENERATORE
DI VAPORE ESTERNO

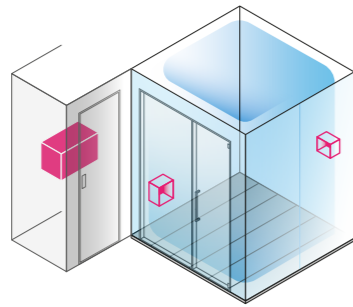

In base al tipo di generatore scelto, occorre predisporre un incavo interno al vano hammam per:

- controcassa
- erogatore di vapore
- pannello di controllo
- cromoterapia (eventuale)

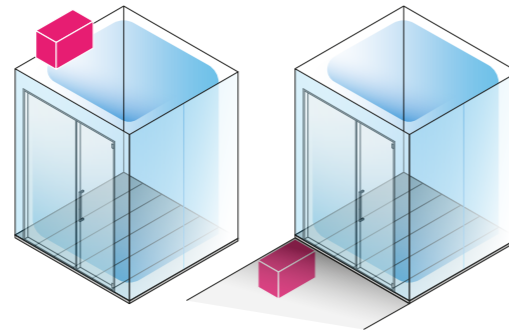

6

**POSITIONING
THE STEAM
GENERATOR**

**POSIZIONE
DEL GENERATORE
DI VAPORE**

Effe's customer service is always on hand to give advice and answer any queries. For information, visit our website: www.effe.it/assistenza/centri-assistenza/

Effe mette a disposizione un servizio di assistenza, sempre disponibile in caso di necessità. Consulta il nostro sito per tutte le informazioni: www.effe.it/assistenza/centri-assistenza/



Installing a steam generator is easy, just follow a couple of simple instructions. Consult our online videos!



www.effe.it/en/products-list/hammam/design-your-hammam/#video

Installare un generatore di vapore è semplice, basta seguire alcuni accorgimenti nel modo corretto. Consulta i nostri video online!



www.effe.it/elenco-prodotti/hammam/progetta-il-tuo-hammam/#video

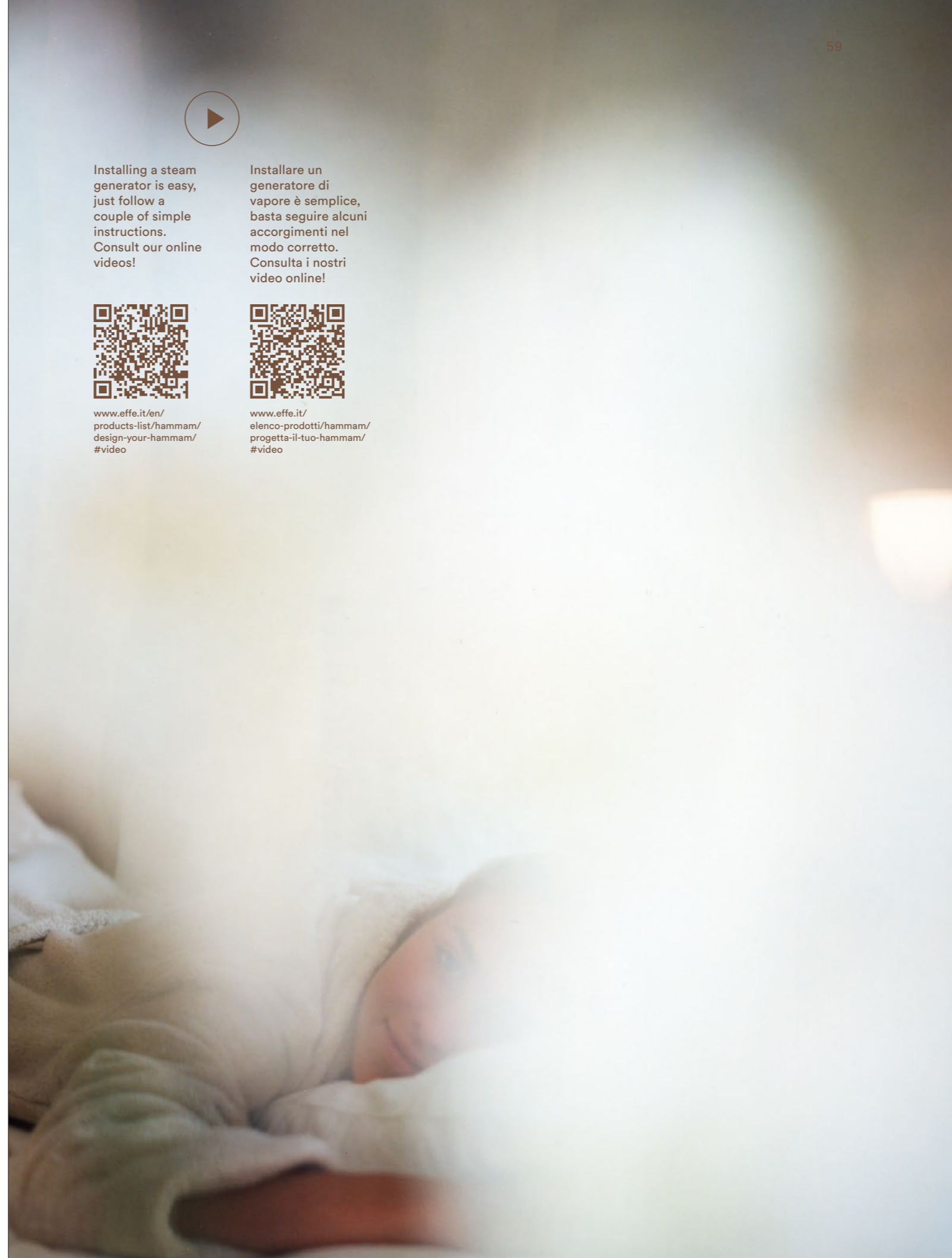

1

GENERATING THE
RIGHT AMOUNT
OF STEAM
AND
MAINTAINING
THE RIGHT
TEMPERATURE

CORRETTA
QUANTITÀ DI
VAPORE
PRODOTTO E
MANTENIMENTO
DELLA
TEMPERATURA

A perfect Hammam is achieved when the steam makes it possible to reach a temperature above 40°C. In Effe products the temperature can be set on a scale from 42 to 48°C. The smart steam management system, the fruit of many years of R&D, ensures even heat distribution inside the Turkish bath.

Un perfetto hammam si ottiene quando il vapore consente di raggiungere una temperatura superiore ai 40°C. Nei prodotti Effe la temperatura è programmabile in una scala che va dai 42 ai 48°C. La sapiente gestione del vapore, frutto di anni di ricerca, ottimizza l'omogeneità del calore all'interno del bagno turco.

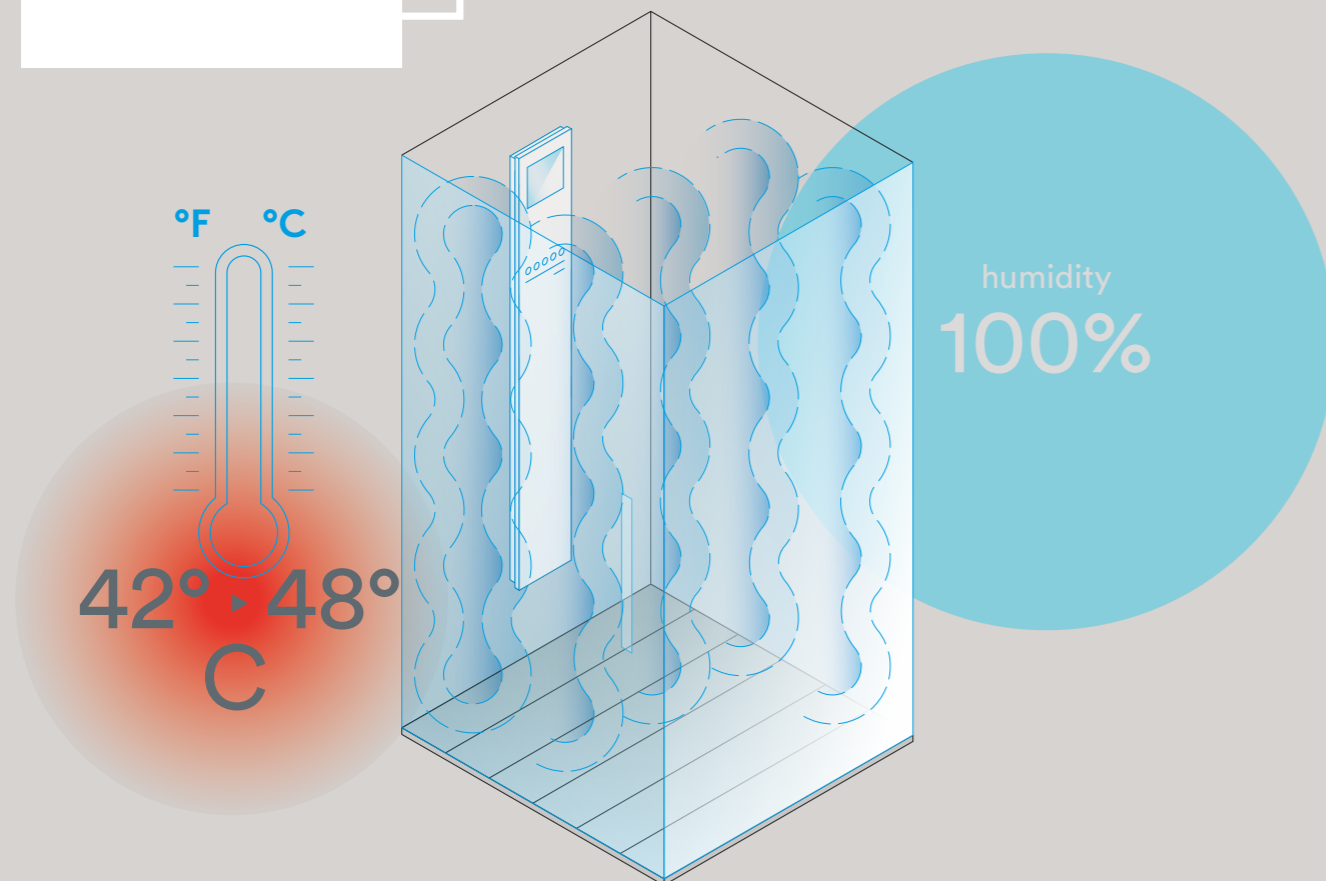

2

LIME SCALE
AND HYGIENE

CALCARE
E IGIENE

Exclusive Effe technology has produced a unique system without mechanical filters on the generators and no need for frequent maintenance. All the boilers are stainless steel and a sophisticated system fills and empties the boiler with clean cold water every time it is used. This notably reduces the need for cleaning and maintenance, as well as ensuring the interior environment is perfectly hygienic.

La tecnologia esclusiva Effe, unica al mondo, consente di evitare filtri meccanici sul generatore e manutenzioni frequenti. Grazie a sistemi sofisticati, la caldaia (rigorosamente in acciaio inox) viene caricata e scaricata con acqua fredda e pulita a ogni utilizzo. Questo riduce notevolmente la necessità di interventi di pulizia e manutenzione, oltre a garantire una perfetta igiene all'interno dell'ambiente.

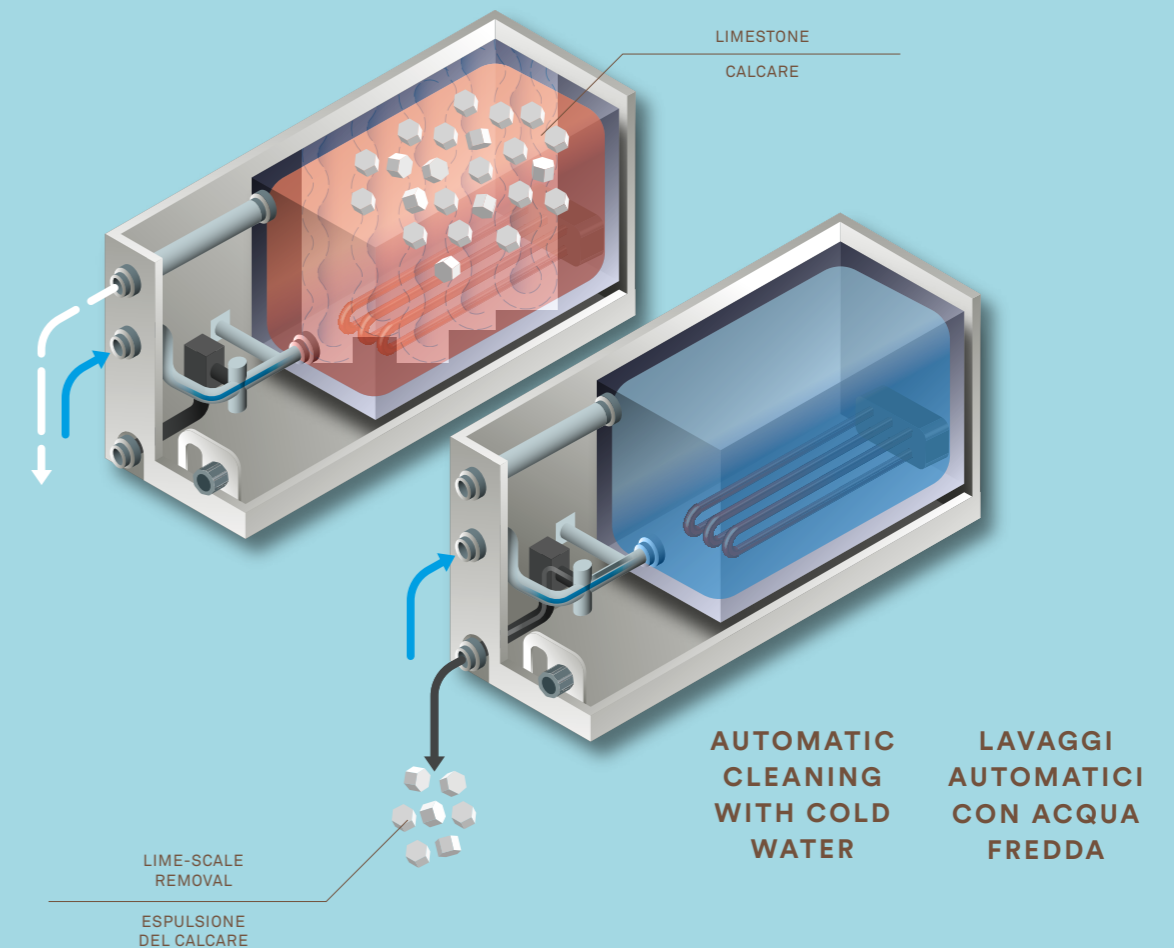

3

**OPTIMISED
MANAGEMENT
OF ENERGY
CONSUMPTION**

**GESTIONE
OTTIMIZZATA
DEL CONSUMO
ENERGETICO**

Each Effe steam generator has an Energy Saver function. The maximum power of the generator is used to bring the water to boiling point and reach the set temperature. While it is functioning the energy input is reduced to a half or a third, depending on the model, while keeping the steam flow constant.

Ogni generatore di vapore Effe è dotato di una funzione Energy Saver. La potenza massima del generatore viene sfruttata per portare in ebollizione l'acqua e raggiungere la temperatura impostata. Durante il funzionamento l'assorbimento viene ridotto alla metà o anche a un terzo, a seconda del modello di prodotto, pur mantenendo costante il getto di vapore.

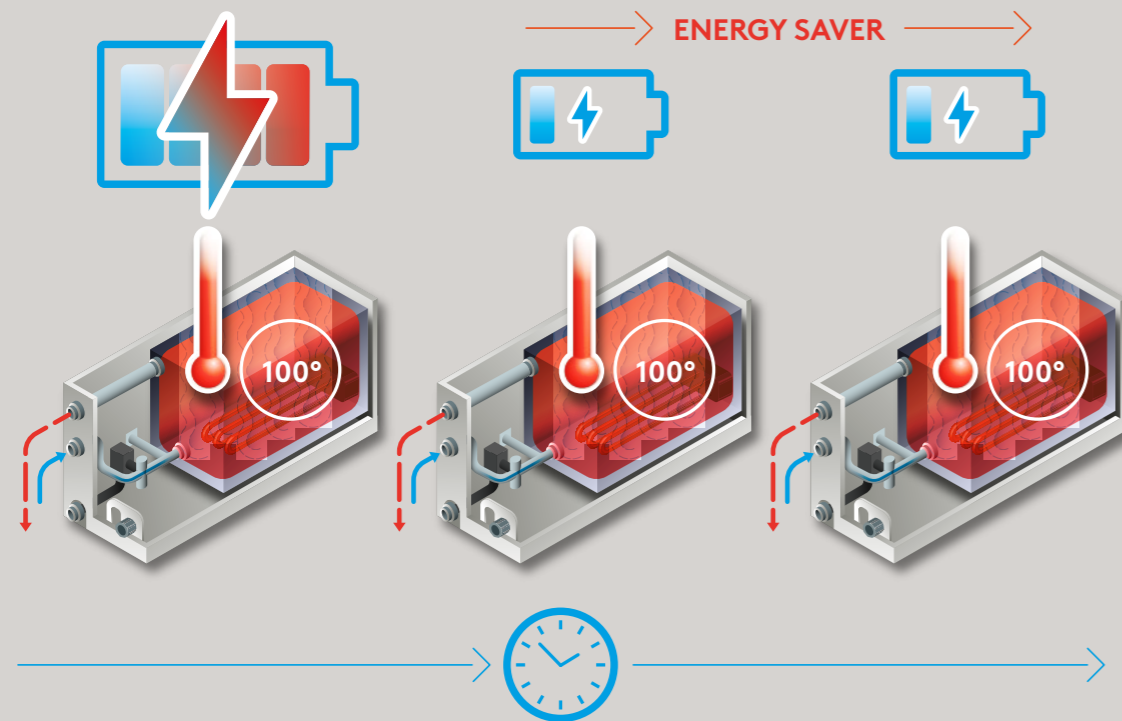

SAFETY SICUREZZA

Effe uses technology that guarantees safety at a number of levels:

1. Electrical and technology system certified by the main international bodies
2. Health and hygiene: the steam we breathe in inside the Hammam cubicle must be constantly purified
3. Extremely long maintenance-free period

La tecnologia utilizzata da Effe garantisce vari livelli di sicurezza:

1. Sistema elettrico e tecnologico certificato dai principali enti internazionali
2. Igiene e benessere: il vapore che respiriamo all'interno dell'hammam deve essere continuamente purificato
3. Elevatissima durata nel tempo senza necessità di manutenzione

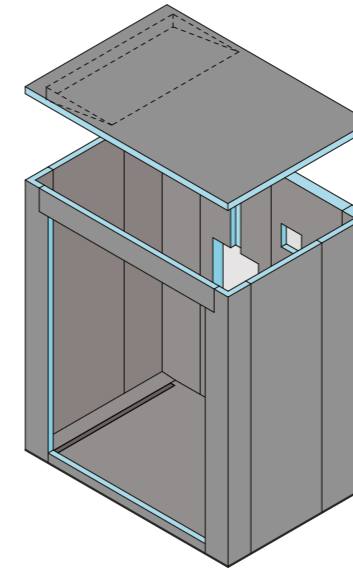

INSULATION ISOLAMENTO

We recommend keeping the Hammam cubicle well insulated from the outside to ensure constant heat and humidity levels. Good insulation also produces energy savings.

Si consiglia di mantenere il vano hammam ben isolato dall'esterno per ottenere un livello costante di calore e umidità. Un buon isolamento permette il contenimento del consumo energetico.

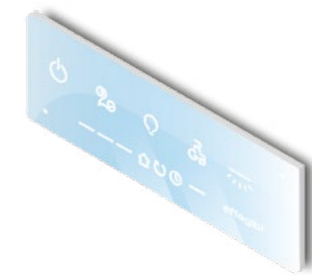

TOUCH-SCREEN CONTROLS

CONTROLLI TOUCH SCREEN

The design of the glass touch-screen control panel teams perfectly with any environment. The backlit icons ensure the controls remain visible even when the cubicle is full of steam

Il pannello di controllo in vetro con comandi touch ha un design abbinabile ad ogni ambiente. Le icone retroilluminate rendono visibili i comandi anche in ambiente saturo di vapore.



REMOTE CONTROL CONTROLLO REMOTO

The ECC (Effe Comfort Control) function lets you programme switch-on of your Hammam, set the temperature and the chromotherapy combination, all from outside your home. Total relaxation will greet you on your return!

Grazie alla funzione ECC (Effe Comfort Control), puoi pianificare da fuori casa l'accensione del tuo Hammam, la temperatura, il colore della cromoterapia. Relax totale al tuo rientro!



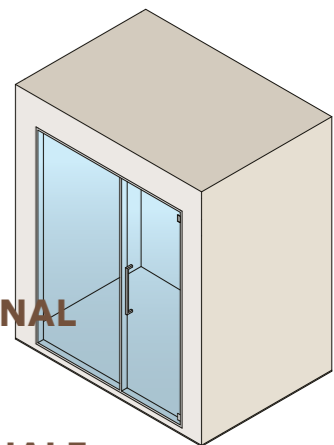





PROFESSIONAL DOOR PORTA PROFESSIONALE



The door is an essential component of the perfect Hammam. It must provide excellent insulation when closed with suitable seals but it should also have well-positioned openings to enable air-exchange.

La porta è fondamentale per ottenere un perfetto hammam. La chiusura deve essere ben isolata tramite apposite guarnizioni ma avere anche aperture, opportunamente posizionate, per consentire il ricambio di aria.

**FEATURES
OF EFFE STEAM
GENERATORS**
**CARATTERISTICHE
DEGLI EROGATORI
DI VAPORE EFFE**

		NUVOLA	NUVOLA SMART POWER	EASYTEAM SMART	AQUASTEAM SMART	TOUCH&STEAM
 PSF - POWER STEAM FUNCTION Steam ventilation system for even heat distribution	PSF - POWER STEAM FUNCTION Sistema di ventilazione del vapore per l'uniformità del calore		✓	✓	✓	✓
 SEC - SMART ENERGY CONTROL Switch on and off distributed evenly over time	SEC - SMART ENERGY CONTROL Distribuzione uniforme nel tempo di accensione e spegnimento		✓	✓	✓	✓
 SBC - SMART BOILER CLEANING Dilution and intermediate rinsing calculated on real need	SBC - SMART BOILER CLEANING Diluizioni e risciacqui intermedi calcolati sul reale fabbisogno	✓	✓	✓	✓	✓
 SWF - SMART WATER FLOW Optimised management of boiler filling and rinsing	SWF - SMART WATER FLOW Gestione ottimizzata di riempimento e risciacquo caldaia	✓	✓	✓	✓	✓
 RWF - REGULATING WATER FLOW A wide range of mains pressures	RWF - REGULATING WATER FLOW Ampio range di pressione dell'impianto idrico	✓	✓	✓	✓	✓
 ECC - EFFE COMFORT CONTROL Remote management from a tablet or smartphone	ECC - EFFE COMFORT CONTROL Gestione a distanza tramite tablet o smartphone		✓	✓	✓	✓
 ODS - OPEN DOOR SENSOR The system automatically interrupts steam distribution when the door is left open for a long time.	ODS - OPEN DOOR SENSOR Il sistema blocca automaticamente l'erogazione del vapore in caso di prolungata apertura della porta.		✓	✓	✓	✓
 ESS - EFFE SOUND SYSTEM Device with Bluetooth connection for listening to music inside the sauna or hammam	ESS - EFFE SOUND SYSTEM Dispositivo Bluetooth per l'ascolto di musica all'interno della sauna o dell'hammam					✓
CALDO DOCCIA FUNCTION Forced-ventilation system for pre-heating the cubicle	CALDO DOCCIA FUNCTION Sistema di preriscaldamento del vano a ventilazione forzata					✓
Steam diffusers with blades to direct the steam flow	Diffusori dotati di alette per direzionare il flusso di vapore		✓	✓	✓	
Additional temperature probe	Sonda di temperatura addizionale		✓			
Touch-screen control panel with backlit icons and temperature gauge	Pannello di controllo touch con icone retroilluminate e misuratore di temperatura	✓	✓	✓	✓	✓
Diffuser for aromatherapy oils	Contenitore per oli essenziali aromaterapia	✓	✓	✓	✓	✓
LED light at the steam outlet point	Luce LED nel punto di uscita del vapore		✓	✓	✓	✓
Lighting system with RGB LEDs and chromotherapy	Sistema di illuminazione con LED RGB e cromoterapia					✓
Fresh water spring with illuminated flow	Fonte di acqua fresca con flusso illuminato				✓	

THE IMAGES AND DATA
CONTAINED IN THIS CATALOGUE
ARE MERELY A GUIDE AND
MAY BE CHANGED AT ANY TIME
WITHOUT NOTICE.

EFFE: ALL RIGHTS RESERVED.
TOTAL OR PARTIAL
REPRODUCTION OF THE TEXT
OR ILLUSTRATIONS IN THIS
CATALOGUE IS PROHIBITED AND
SUBJECT TO LEGAL SANCTIONS.

LE IMMAGINI E I DATI CONTENUTI
NEL PRESENTE CATALOGO SONO
DA RITENERSI INDICATIVI E
POSSONO SUBIRE VARIAZIONI
ANCHE SENZA ALCUN
PREAVVISO.

EFFE: TUTTI I DIRITTI RISERVATI.
OGNI RIPRODUZIONE TOTALE
O PARZIALE DEI CONTENUTI
DEL PRESENTE CATALOGO, SIA
DI TESTO CHE DI IMMAGINE, È
VIETATA E SARÀ PERSEGUITA A
TERMINI DI LEGGE.

ART DIRECTION
& GRAPHIC DESIGN:
ZUP
PRINTING:
OGM, PADOVA
PHOTO:
SIMONE CASSETTA
PHOTO P. 18-19; 36-37:
EFFE ARCHIVE

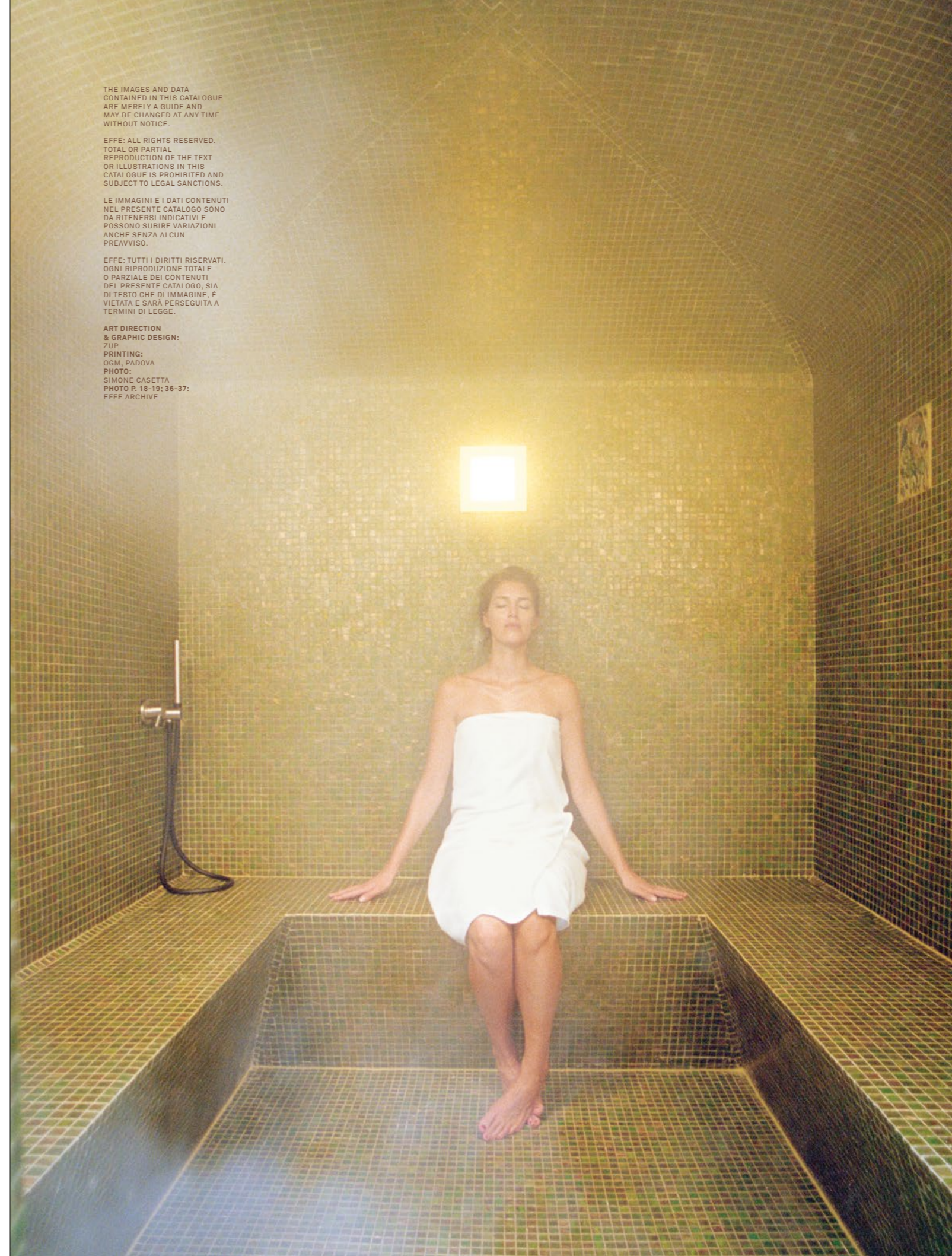



effe

PERFECT WELLNESS

Effe
Via Gallo 769
47522 Cesena (FC)
Italy
www.effe.it